

Blotting Out the Truth

The stunning discovery of a century-long cover-up of the real beginnings of L. E. Waterman's Ideal Pen Company

By George Rimakis and Daniel Kirchheimer

“Many business men in America today fear to face the facts! Many men are ashamed to do so! All have skeletons; how many hide them, bury them, cover them over, gloss them over; and how many dig them out, turn on the sunlight, bring them to the surface, ruthlessly get the facts, no matter what they are, and then do what is necessary to set their houses to rights?”

– [“How Waterman Won,”](#) *Editor and Publisher*, August 13, 1921

“It takes a thousand men to invent a telegraph, or a steam engine, or a phonograph, or a photograph, or a telephone or any other important thing—and the last man gets the credit and we forget the others. He added his little mite—that is all he did.”

– Mark Twain, [letter to Helen Keller](#), March 17, 1903

The story is a familiar one, and it has been repeated countless times for over a hundred years. In the latter part of the 19th century, a working man, frustrated by the skipping and blotting of the early fountain pens he tried, declared that a fortune awaited the person who could develop a practical fountain pen. After intense toil in a wagon-maker's workshop, he succeeded in crafting a feed for a fountain pen in which he had enough confidence to apply for a patent. In mid-1883, ready to market his invention, he abandoned his former profession and set up shop in the back room of a cigar store on Fulton Street in New York City. He began assembling his products, placed his first advertisement, and started to sell, one at a time, his simple black fountain pens with a distinctive stepped gripping section and his unique feed.

From these humble beginnings would emerge the L. E. Waterman Pen Company, which would grow to become a massive global corporation that would dominate the pen industry for decades—and it all started with the dream of that one driven man and the pen he invented. There is, however, one detail of this true story that may come as a surprise.

That man was not Lewis Edson Waterman.

History is Written (and Rewritten) By the Victors

The classic Waterman ink-blot story, in which Lewis Edson Waterman, insurance salesman, lost a big client due to the failure of an early fountain pen, leading to his invention of the first “practical” fountain pen, has long been debunked as the likely creation of a shameless marketing department decades after

the supposed events, and long after Waterman's death in May of 1901. Though more investigation is warranted—and now, has been undertaken—to piece together the genesis of this tale, a larger question looms: If the ink-blot story is a myth, what was L. E. Waterman *really* doing before making his own fountain pens that led him into that business? And might his activities have included some pursuit that he, or those around him, did *not* want to have become part of his legend as an inventor who was driven only by his passion to solve a problem that had vexed him, and who used whatever crude implements he, a simple insurance salesman, had at his disposal? And did the L. E. Waterman Company go so far as to deprive another inventor and pen maker of his due, blotting the other man out of history?

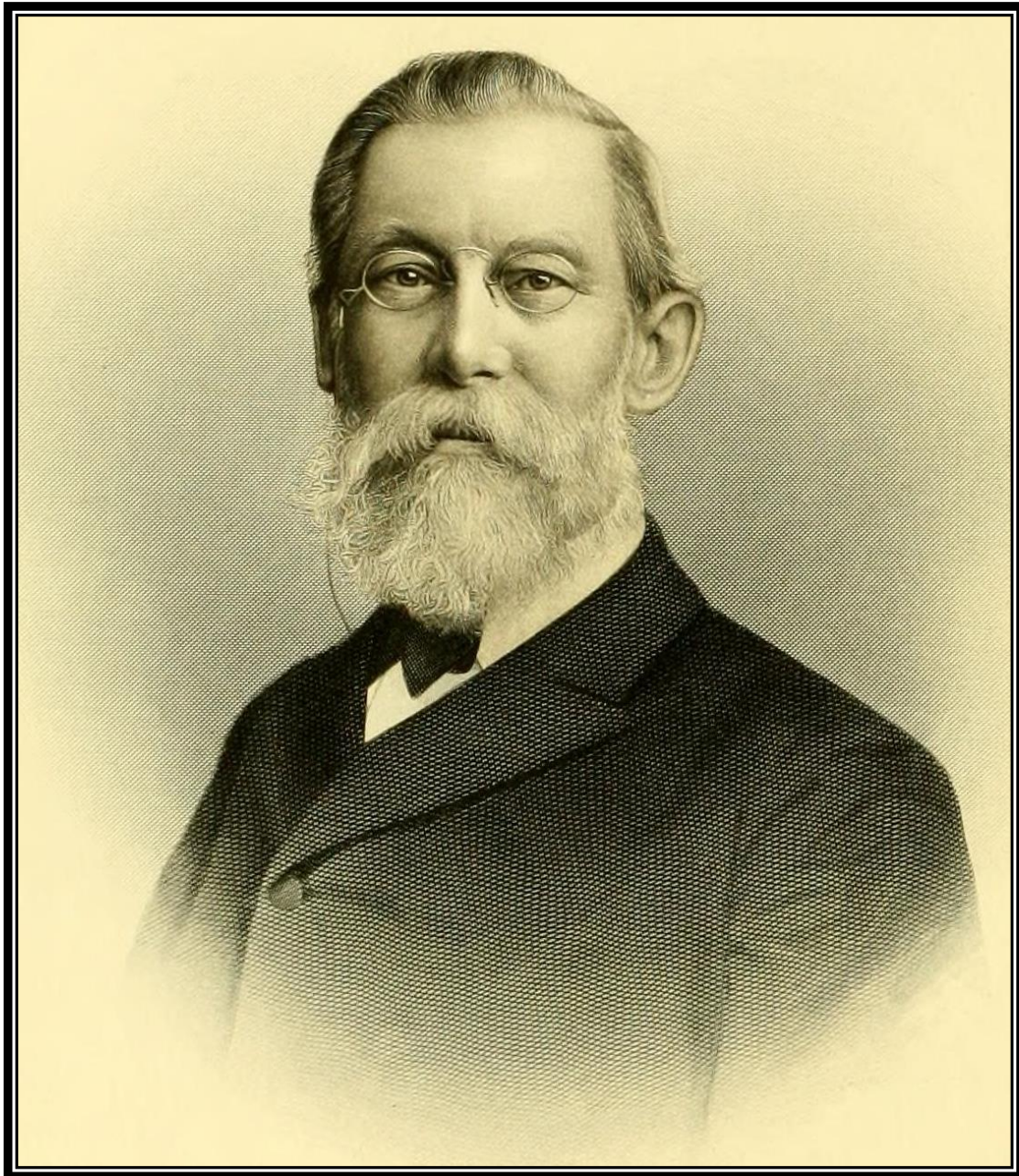

Figure 1: Lewis Edson Waterman (from Contemporary American Biography, 1902)

The Indelible Blot

As detailed by several writing instrument historians, the Waterman ink-blot story is one of the most persistent and widespread myths in the field, and perhaps ranks among the longest-running fables in the history of invention. [As historian David Nishimura put it](#), “a closer examination of earlier Waterman literature leaves no doubt that the tale was a complete fabrication.” Many modern books and periodicals faithfully—and unquestioningly—repeat the story, and some even add their own variations, whether out of sloppiness or an overzealous use of creative license. A typical latter-day example follows, from Stephen Van Dulken’s 2001 book, *Inventing the 19th Century: 100 Inventions that Shaped the Victorian Age*:

One day [Waterman] decided to impress a client by lending him a new fountain pen to sign a contract. Such pens had been known for a long time, and needed to be dipped frequently into an ink well, so that the ink well had to be carried around by the writer. This model promised to store a reliable supply within the pen itself. The client tried to sign, but no ink flowed. He tried a second time, a third. Then the ink did flow, but so much that a large ink blot was left on the contract. Waterman did not have any blank copies and he rushed to his office and hurried back with a fresh contract, but too late. Another salesman had beaten him to it.

Modern recountings vary in the particulars, both large and small; another book, this one from 2011, gives the date as 1844 (clearly an erroneous reference to 1884) and claims the offending pen was a “quill pen” (from the ironically-named *Philip Ardagh’s Book of Howlers Blunders and Random Mistakery*), and a web site version even solemnly states that the coverage amount of the life insurance policy that was lost was \$50,000 ([“Tough times are met by tough people,” Whittier Daily News, 5/27/2009](#)). Even the present-day incarnation of the Waterman company is not immune from this fantasy; [the “Heritage” page](#) on their corporate web site proudly retells it, and for good measure also throws in an inaccuracy about the original feed design:

After losing a big sale with a client because of a leaking fountain pen, the then salesman Lewis Edson WATERMAN invents the "Three Fissure Feed" system. The system prevents for the first time the excessive discharge of ink when the pen is in use.

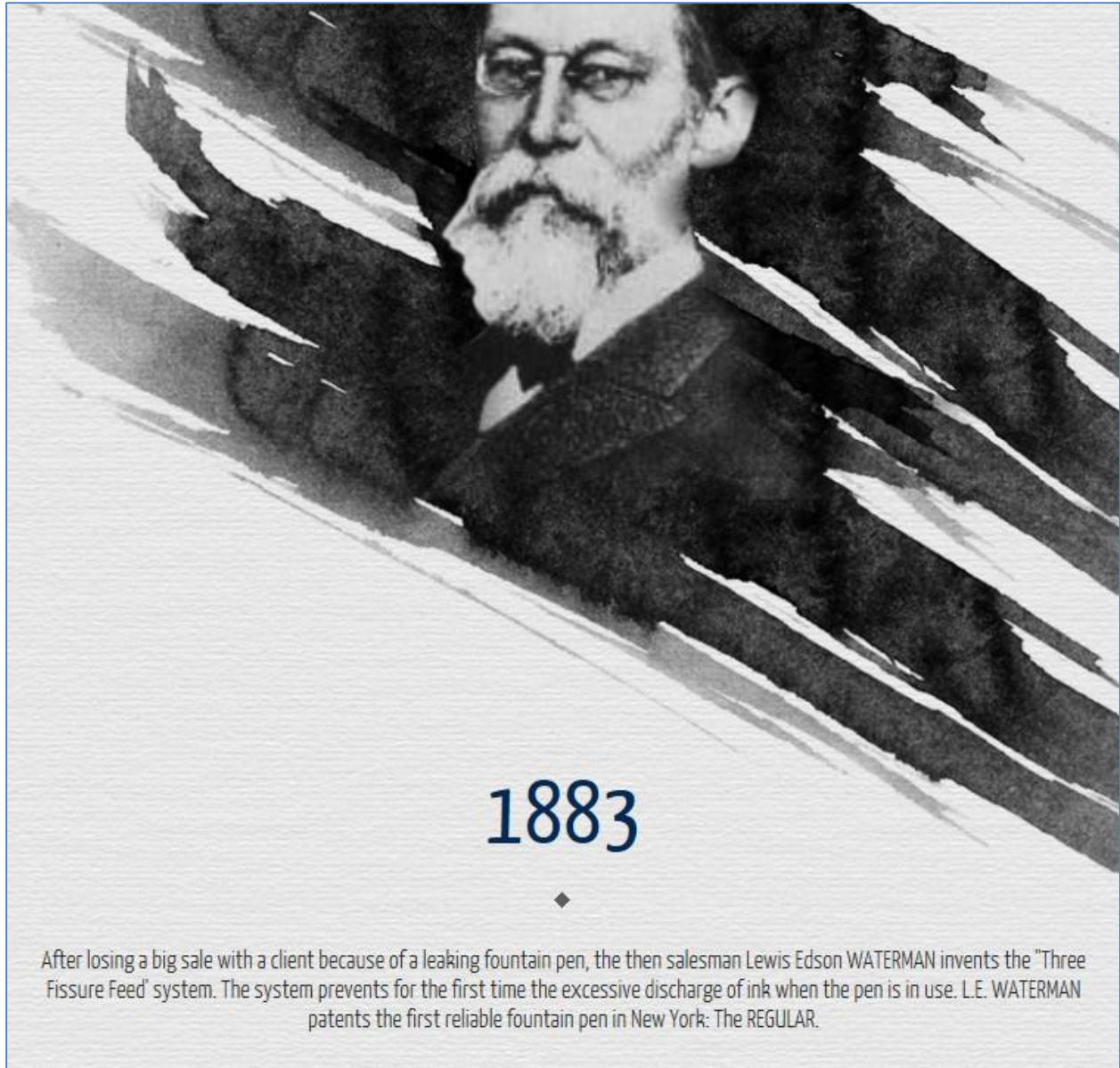

Figure 2: Ink blot tale referenced on Waterman company's web site, March, 2014

But of far greater interest to the fountain pen researcher are the many forms the story took in its earliest decades, and the picture that emerges from the timeline that can be discerned.

The Ink-Blot's Golden Age

David Nishimura observed that the date of the first known appearance of the ink-blot story had been progressively moved back from the mid-1950s, into the 1930s (when Waterman's ostensible 50th anniversary was observed), and then back to December of 1921. Some digging revealed that the early 1920s saw a spate of printings of the tale in various periodicals; this one pushes back the first appearance by a few months, as it is from the [August, 1921 issue of *New Science and Invention in*](#)

[Pictures](#), where an article appeared entitled, “Inventions That Have Earned Wealth: Story of the Fountain Pen:”

Inventions That Have Earned Wealth

After trying carpentering, school teaching, and a position as instructor in the University of Virginia, Lewis Edson Waterman took to soliciting life insurance in 1880 when he was 43 years old. Learning by sad experience, as many another man has done, that prospects often change their minds, while hunting for a pen to sign an application for a policy, Waterman armed himself with a fountain pen one day, when he hoped to sign up a candidate for a big policy.

At that time more than two hundred patents for fountain pens had been issued and many varieties of such pens were on the market. They were good average pens, too. That is to say sometimes they wouldn't give down any ink at all; at other times they would give it down by the gallon; but the average was all right.

As Waterman's victim touched that fountain pen to the dotted line, it let out a great blot of ink in a sudden access [*sic*] of generosity, flooding the paper so that it had to be thrown away. While Waterman hurried back to his office to make out a new form, a rival came along and signed up the prospect.

This so embittered Waterman that he abandoned the life insurance business and turned his attention to the development a fountain pen, that would write. After three years of tireless experiments, that always ended in disappointment, he hit upon the right idea. His first patent was granted in 1884.

Other versions added incredible detail and embellishments; the version that appeared in the December, 1921 *Printers' Ink* and re-told in the [May, 1922 American Exporter](#) piled on the romance of the event under the headline, “Ink Blot led to a Fortune”:

INK BLOT LED TO A FORTUNE

About forty years ago an ink blot from a faulty pen lost a contract to L. E. Waterman, insurance solicitor, but brought into existence an inspiration which resulted in the invention of a fountain pen today leading the industry.

Lewis Edson Waterman, born at Decatur, Illinois in 1837 [Waterman was actually born in Decatur, New York], having had few opportunities for education, was in his 45th year when chance played the part that marked his destiny, and gave the world a better pen.

He was at that time an agent for a large New York life insurance company. In order to be an efficient agent, he had always carried a tiny, non-spillable ink bottle tied to a button of his waistcoat. One morning, on his way to secure a signature to what was in the days a

big policy, he bought one of the new fountain pens, —an invention which had just come into the market, —thinking to make a good appearance with it before his prospect.

When Mr. Waterman met his prospect he presented the application blank, and then the new fountain pen. As the latter touched the pen to the paper there appeared a blot. He tried again—another blot; again—and the pen was empty! The prospect was a superstitious man, and when Waterman offered his ordinary pen dipped in the little ink bottle, he refused to sign, regarding the failure of the first pen as a bad omen.

Obviously, the details are rather different. But the accessorizing has just begun; the article goes on to describe the amazing process by which Waterman created his invention:

Waterman was ordinarily mild-tempered. But that pen made him mad. It had worked all right for him, for he had tried it so as to be sure. It was one of those pens that worked all right when full. Waterman had tried it so much he had nearly emptied it. That was why it blotted.

Being in poor health, Waterman shortly after went on a visit to his brother, a wagon builder. There by a stroke of genius he solved the fountain pen problem with a simplicity that no one else had ever thought of.

With a pocket knife, a saw and a file for tools, a pen [nib] made of hickory wood, and a spoke of an old broken buggy wheel for a holder, he made a fountain pen....

His new pen attracted attention among his friends. One day a life insurance prospect asked to be allowed to buy it, and as a matter of good business ethics, Waterman sold the pen. This was the first Waterman sale [....]

In a little vacant space beside a cigar stand, in the entrance of an office building in New York, the business of making pens was begun. In the first year Mr. Waterman made 200 pens; in the second, 500; all were made by hand, though by that time he was using hard rubber.

This version is largely repeated in a recounting in [a 1926 issue of *Printers' Ink*](#), though that later article adds the embellishment of a “kindly landlady” who lets Waterman slide on his rent while he struggles to get his feet under him in his new business. The discovery of that fact 43 years after the events in question is a testament to journalistic sleuthing, we suppose.

The Zaniest Version

An August, 13, 1921 article in *Editor & Publisher* in a section exhorting readers to use advertising to its fullest puts forth a completely different version of the events that is so bizarre it is worth repeating here; it is entitled, “[How Waterman Won](#),” and a quotation at the start of this paper is taken from its introduction. It says:

L. E. Waterman, he of fountain pen fame, was at one time a buyer and seller of white space; an advertising agency. He was making wealth for others for whom he bought space and wrote ads. Said he once: “Why should I make fortunes for others! Why not for myself?”

One day he saw a blind man selling a pen holder that carried the little bottle inside. The idea of increased service (similar to Pullman [of railroad sleeper car fame]) struck him forcibly. “How much better is it to carry a bottle of ink and write with ink rather than pencil.”

Why not sell these “fountain” pens? He bought space, wrote ads and extolled the superior advantages of the pen that carried its own ink. He reckoned without his host [forged ahead with little planning]. The world had been “sold” to the Spencerian steel pen. He hammered away. Eventually orders began coming in. He then had to look up the blind man to see where he bought them. They were made “by a man named Swan over in Jersey.” He bought a few gross, filled his orders, kept on advertising. He increased his space; increased his orders and was soon taking the entire output of this “man named Swan over in Jersey.” He bought still more space and soon had Swan enlarging his plant to take care of Waterman.

Here was a peculiar situation. The idea was Swan’s; the patent was Swan’s; the rights were Swan’s; but he forfeited his rights because he didn’t use them. Swan was a factory; Waterman was a salesman. He taught Swan a lesson.

No blotted contract or late nights whittling feeds here; Waterman is not even in the insurance business. No first primitive workshop and office in a cigar shop—in fact Waterman invents nothing, he never makes any pens himself, and he doesn’t even have any in hand until after he advertises and has to fulfill orders! And let’s not overlook the inclusion of the blind penseller as the crowning touch. Though rife with fabricated details, this version inadvertently contains echoes of some real events, but that discussion will come a bit later.

The Blotless Blot Story

A slightly earlier description of the blot incident is found in the June 11, 1921 [American Stationer and Office Outfitter](#). This version differs in a key respect, and it also has its share of freshly-minted verbal adornment. It is aptly titled, “Fountain Pen’s History is Full of Business Romance,” and the attention-testing subhead reads, “Interesting Account of How L. E. Waterman, as an Insurance Agent, Invented His Fountain Pen in 1883 so as to Avoid Carrying Around with Him a Vial of Ink in which to Dip His Pen for Contract Signatures—Advertising Solicitor helped Inventor to Bring Pen Before the Public.” It proceeds thusly:

Fountain Pen’s History Is Full of Business Romance

Interesting Account of How L. E. Waterman, as an Insurance Agent, Invented His Fountain Pen in 1883 so as to Avoid Carrying Around with Him a Vial of Ink in which to Dip His Pen for Contract Signatures—Advertising Solicitor helped Inventor to Bring Pen Before the Public

Eighty-four years ago, in the little village of Decatur, N. Y., Lewis Edson Waterman was born. His was the usual story of the poor country boy who did all the chores on his father's small farm [an apparent reference to Waterman's stepfather, as Waterman's father was a wagon-maker who died when Lewis was three]. But the story of his rise from poverty and comparative obscurity to be one of the world's leading manufacturers of fountain pens, is, or ought to be, of interest to all stationers.

In his early manhood Waterman had been a professor in the University of Charlottesville, Va., later becoming a life insurance salesman in New York City. It was necessary at that time, as today, to have the insurance application blank signed in ink. Waterman had a small glass vial of ink, with a protecting wire around the neck, attached to a ring on his finger. He carried an ordinary dip pen in his pocket, and when he sold a policy he removed the cork, dipped the steel pen in the bottle and asked the applicant to sign his name on the contract blank.

One of his customers laughed at this crude device and asked Waterman why he did not invent some method of carrying the ink in his pocket. That suggestion started the insurance man thinking and he decided to create a safe receptacle for his ink. He feared to carry a glass bottle around in his pocket as it was in constant danger of being broken.

Waterman's early experience as an insurance solicitor taught him the difficulties that lay in depending on the old-fashioned imperfect stub [*sic*] pen. "Why," he thought, "can I not make a pen with a receptacle for ink, at the same time regulating the flow of ink so it will not leak or sputter?" He started experimenting with this idea in mind and soon made his first pen.

Waterman learned that others had the same idea and that the market had been flooded with stylographic pens. But he investigated those and found that they had all proven unsatisfactory. Becoming fully acquainted with their deficiencies, and learning what to avoid in making a reliable fountain pen, he perfected his own invention.

Waterman's first experiments were fairly successful. The first fountain pen he made had a wooden barrel and ink feed, but he soon discovered that the acids in the ink rapidly corroded the barrel and clogged the feed. Further experiments with various materials taught him that rubber was the only substance that would give entire satisfaction. [...]

Waterman received his first patent for a fountain pen February 14, 1884 [the correct date is actually February 12]. That is the date of the issuance of the patent, but Waterman's first pen was made a year prior to the granting of the patent. When he had obtained his patent, he immediately set to work and had twenty-four hard rubber barrels made from his own design. He secured an equal number of gold pen points, embodying his original ideas, and adjusted them to the holders.

Waterman's next step was to secure a small business place, which happened to be a kitchen table in the Owl Cigar Store, in the Commercial Advertising Building, then situated at the corner of Fulton and Nassau streets, New York City. [...]

This story is different from the others in an essential way: there is no ink blot at all! (We also note that the Lilliputian ink bottle is on LEW's finger, rather than tied to his waistcoat.) As with most other versions, this discussion of Waterman's toil concludes with a description of his first production and sales from the humble space he secures next to, behind, or within a cigar store on Fulton Street in New York City.

Perhaps this version, pre-dating the others by a just a bit, actually reveals the myth in the process of forming, and the central detail of the blotted contract had not yet crowned the story. Were the months following the summer of 1921 the gestation period for this legend?

The Earliest Known Version

The answer is no. The authors have uncovered an earlier reference still, and it is far earlier. The May, 1912 issue of *Pearson's Magazine* contained [the following account](#), entitled "Backbone vs. Wishbone; the story of L. E. Waterman, who through hard luck as an insurance agent found a way to lighten the writing man's burden:"

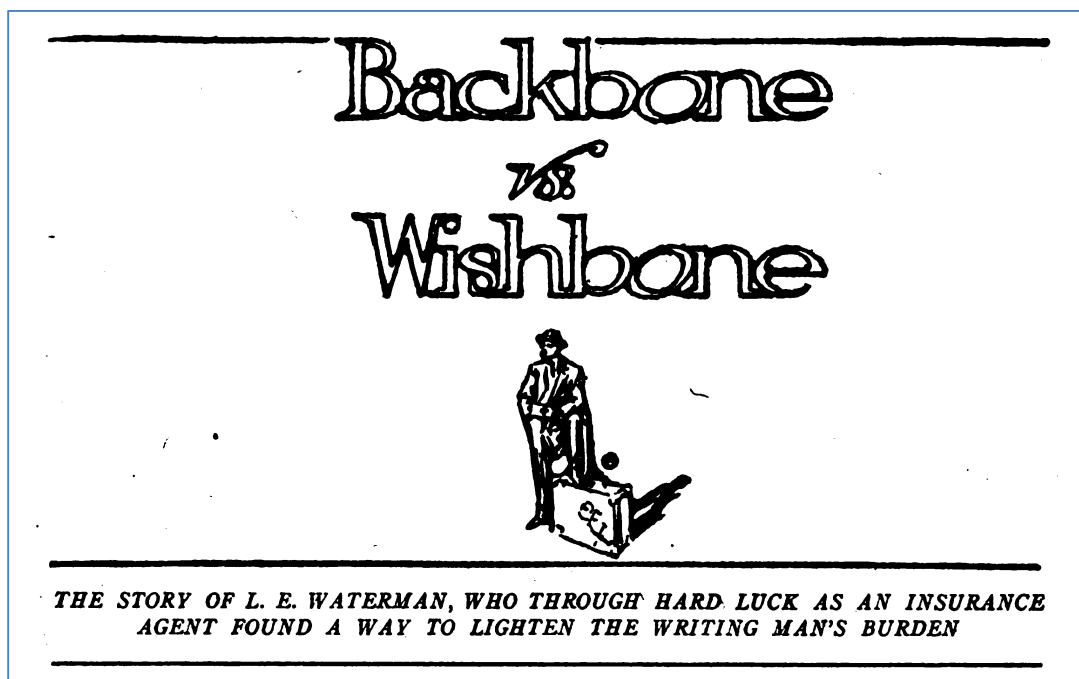

A gentleman sallied forth to write a New York building contractor for life insurance. Everything had been settled except the "signature upon the dotted line" of the application. During a series of confabs that lasted for weeks, every conceivable sort of policy had been considered. The "whole life" had been balanced against the "twenty-payment life." The twenty-year endowment" had been matched against the "ten-year gold bond." Also had been threshed out the question of "participating" and "non-participating." The gentleman who was so artfully being made to believe he wanted insurance either understood all of these matters, or was convinced he never should. At any rate, he had told the agent to come around the next morning and write him up.

The next morning having arrived, the agent, as we have said, sallied forth. Upon such an occasion, no insurance agent needs an alarm clock in order to get up in time to sally. He has the lark beaten a block. With large money in sight, the quilts are no comfort to him after daylight.

This particular agent was at the contractor's office promptly upon time. He brought with him an application for insurance that had been filled out ready to be signed. But he might as well have been an hour late. Business had suddenly called the contractor up town. Nobody in his office knew when he would be back. The office force simply knew that he was standing around the excavation for an office-building foundation and might not be back until late in the afternoon.

The life-insurance agent beat it to the place named and found the man. The contractor made ample apologies for his failure to keep his appointment. The agent intimated, "tush-tush," and produced his signatureless application. The contractor replied that he was as good as his word, but he did not see how he could keep his word just then because the work at hand prevented him from leaving the place to find pen, ink and a place to write.

With the utterance of those kind words, the broad smile that swept over the face of the agent was a sight to see. He was prepared for precisely such an emergency. He drew from an inner pocket a fountain pen and gracefully presented it to the prospective policy-holder.

The contractor took the pen, knelt down beside a beam which he sought to use as a desk and began to write. On second thought it would be more nearly accurate to say that he began to try to write. He scratched three or four times at the first letter of his name without making a mark. Then all of the ink in the pen seemed to come down at once, with the result that he made a blot as big as a cent.

The contractor was somewhat mortified, as old ladies used to say when they meant that they were embarrassed. The making of a big blot instead of a signature seemed to indicate that he did not know much about the use of pens. The agent emphatically assured him to the contrary, and urged him to try again. The contractor did not like to try again, evidently feeling that so large a blot upon so portentous a paper was a bad omen, but he was finally induced to do so. But it was no use. He might as well have tried to write with a knitting-needle. Not a particle of ink would come down. The pen had simply gone on strike.

The article goes on to explain that after losing the client to another agent, Waterman, apparently in short order, set to work addressing the problem and crafted a feed of his own design, which he installed into the body of the very same fountain pen that had failed him. He had no intention of marketing his invention; he simply carried it so insurance contracts could be signed without disaster. The time then came when an observer asked Waterman to make him another pen like it:

Mr. Waterman's change of occupation came about in this way. Always an enthusiastic man about whatever he did, he was particularly enthusiastic about the pen he had made.

Every time he signed his name in the presence of anybody, he told what a great pen he had made. Of course, everybody to whom he told the story wanted to try the pen and, having done so, agreed with him in all he said. One day, a man said to him: “Waterman, what will you take to make me a pen like that?”

Mr. Waterman, who was not in the pen business, did not for the moment know what to say. Finally he said he would make a pen for nothing, provided he were furnished with an old-style “pen-barrel” to which to fit his attachment. But the question gave him the first suggestion that there might be a market for a really good fountain pen.

The next step in the evolution of the Waterman fountain pen teaches us that we may expect to get from a cigar store almost any good thing except a good cigar. Mr. Waterman set up as a pen manufacturer in the rear of smoke-shop. He did not quit the life insurance business right away, but whenever he had time to spare, he put it in at the pen business. His raw materials were the completed pens of other manufacturers. His tools were a file and a jackknife. His weekly output was perhaps half a dozen pens, which were retailed over the counters of the tobacconist.

This 1912 article is the earliest version of the ink blot story the authors have discovered to date, and it is interesting for its richness of detail. All the classic elements are present—an early fountain pen failing Waterman by blotting in the hand of a hot prospect on the verge of signing a big contract, Waterman’s resulting frustration and invention of an improved feed, and the first manufacturing and sales in a cigar shop. However, there are some specific details that appear to be unique to this 1912 version that never reappear: the use of another maker’s pen into which Waterman fitted his feed, both when devising it and when initially selling fountain pens from the cigar store. Recall that later versions have him hacking out a complete pen from wood scraps at his brother’s wagon-building workshop; by the early 1920s, the maker of the pens Waterman had used as holders for his feed in the 1912 version was not just anonymous, as in that version, he was nonexistent, having been eradicated from Waterman’s backstory. It’s an interesting detail, because unlike many others, it does not seem to have been chosen to puff up the story; to the contrary, it somewhat diminishes Waterman’s otherwise solitary effort in getting his company off the ground, compared with the versions where he starts with absolutely nothing, carves a prototype pen from a wagon spoke, and then sets about manufacturing complete pens of his own design. This early version also does not affix a duration to Waterman’s single-minded quest to devise a workable fountain pen, though the implication is that it was not a lengthy effort, which corresponds to some of the later stories, in which Waterman attacks the broken wheel spoke with his rudimentary armament and apparently carves out his place in history in short order.

The Egg from which the Ink-Blot Story Was Born?

Though the 1912 article represents the earliest mention so far uncovered of an ink blot leading to the invention of Waterman’s pen, we have found an even earlier description of the birth of Waterman’s creation that has many similarities, despite lacking the detail of the blot itself. The February 11, 1905 edition of *Harper’s Weekly* ran a piece entitled, “[The Pen that has Reached its Majority – The Triumph of ‘Ink in Hand’](#).” The occasion was the 21st birthday of Waterman’s invention—or, more accurately, of his

first patent grant, which occurred on February 12, 1884—and the magazine detailed thusly the conditions in which Waterman’s invention sprouted:

HARPER’S WEEKLY ADVERTISER

The Pen that has Reached its Majority—The Triumph of “Ink in Hand”

Mr. Waterman early in life was an insurance solicitor. He wanted pen and ink frequently for use on the spur of the moment. Get the man to sign at once is a cardinal principle of that calling. So as not to lose a customer at a critical moment, he used to carry in his pocket a pen in a case and a small bottle of ink. The ink would give out occasionally and the pen would rarely be exactly suited for the customer, and he set himself to devise a pen with ink in the holder that would readily do the required work.

Here we can see the zygote of the ink blot story—“so as not to lose a customer at a critical moment”—but the offending blob does not yet make an appearance. Though, again, there is a seamless transition between Waterman’s insurance sales and his solitary development of his fountain pen; there is no intimation that he was involved in any activity that could have aided his entry into the writing instrument manufacturing business. He arrived there through sheer determination, apparently.

If Not the Blot—What?

So what *was* Waterman really up to in that crucial period just before he became a penmaker, if he was not ruining clients’ insurance policies and carving experimental pens from wood? What circumstances conspired to create the conditions for what could be considered the most important moment in fountain pen history? As we look further back at the retellings of Waterman’s beginnings to a time before the ink-blot story is born, there is no dramatic motivating event at all, though some elements of the later story are in evidence.

One of the [earliest profiles of Waterman](#) appeared in Volume 1 of *The National Cyclopædia of American Biography*, copyrighted 1891. He was still alive at the time, and, judging by the cornucopia of compliments heaped on him in the fawning entry, he took full advantage of the work’s questionnaire-based method of biography compilation. There is no ink blot story here, but there is nothing really in its place; a curious vacuum exists in the period leading up to his entry into the pen business:

Mr. Waterman was left a fatherless orphan at three years of age. Until he was fifteen years of age he had no other educational advantages than the district school. After this he attended the seminary at Charlottesville, N. Y., for three months [the town is actually Charlotteville—this is consistently misspelled in Waterman biographies]. He was a close student, and fond of his books, and improved his mind during “the long winter evenings by the light of a tallow dip.” He commenced teaching at the age of fifteen, and one year later he removed to Illinois, where he taught school in the winter, and worked at the carpenter’s trade in the summer. He continued his studies without a teacher, and acquired a thorough knowledge of Pitman’s system of phonography [a shorthand system based on

sounds], which he afterward taught in the University of Virginia. In 1864 he removed to Boston, Mass., as the representative of the Ætna Life Insurance Co. of Hartford, Conn. He continued with the company until 1870, the business having largely increased during his connection with it. In 1883 he removed to New York city, and began experimenting in fountain pens.

The piece goes on to laud Waterman's brilliance and character; here is but a sample:

In the various occupations of life he has almost invariably achieved success where others have failed. As a school boy he could solve the most difficult problems, and as a teacher could interest in their studies those scholars who had previously been the bane of teachers, and through his efforts they became the best-behaved scholars in school. As a life insurance agent he displayed remarkable tact and ingenuity, and succeeded in interesting parties who were considered incorrigible and hopeless by other agents. He was persevering and persistent, yet never gave offense. His manner of presenting a subject is pleasing, impressive and convincing, apparently with little or no effort on his part.

In this profile, there is no mention of any connection between Waterman's insurance sales and the turning of his attention to the improvement of the fountain pen, nor is an alternative explanation offered—his seemingly abrupt entry into this completely new field of endeavor is left unexplained. Indeed, this profile leaves a yawning gap of 13 years between 1870 and 1883. Shortly after Waterman's death in 1901, a [more extensive profile](#) published in *Contemporary American Biography* added a bit more detail to Waterman's activities during this period:

By 1870 he had so built up the business of the Boston [Ætna] agency that it alone exceeded the total of the company's business when he took charge. In this year his health gave way under this strain; and thenceforward, until 1883, he spent a great deal of his time travelling over the States with a "roving commission," greatly to the improvement of his physical well-being.

Though this version states that Waterman began working on an improved fountain pen in 1880, once again there is an emptiness that seems to be filled later with the frustrated insurance agent story in one form or another.

The Men on the Scene Give Their Versions

As mentioned earlier, one detail that does seem to appear with regularity throughout the years is Waterman's decision to set up shop in a cigar store on Fulton Street, wedged in a bustling business district in New York's lower Manhattan. In addition, several versions relate that Waterman was subsequently "discovered" peddling his pens at the smoke shop by an advertising agent who happened by, and who convinced Waterman to place his first advertisement. That ad led to a huge increase in sales, and catapulted Waterman's business to success.

The advertising agent was Edward Tasker (E. T.) Howard, whose office was located nearby at 23 Park Row, and Howard's firsthand account of Waterman's first struggling days in business and subsequent rise to success was published several times in a variety of trade publications during the early years of the 20th century. The earliest version of Howard's retelling that we have located appeared in the [December 30, 1903 issue of *Printers' Ink*](#):

The initial Ideal Fountain ad dates back twenty years. When I first called on Mr. Waterman, back in the early eighties, he had a case containing not over four dozen fountain pens in a little cigar store in [*sic*] Fulton street. He had never seriously considered advertising in the magazines before, and after some talk, I succeeded in persuading him to run a quarter page in the *Century [Illustrated Monthly Magazine]*. This was during the time when the *Century* magazine was running its famous series of war articles [consisting of reminiscences by hundreds of Civil War leaders from both sides]; its circulation was something like 250,000 or over. Mr. Waterman had to be trusted for the bill, as he had no money to pay for his ad. Since this first ad appeared he has never been out of the magazines, particularly the *Century*, in which not a single issue has been missed—a quarter page being the minimum space representation [though in fact, the very next issue was skipped].

Mr. Waterman had very decided views regarding what a fountain pen should be, and he was very dissatisfied with the then existing specimens. After considerable experimentation, he perfected his own design and went to work to make the Ideal.

....

Before his first advertisement worked a revolution in the manufacture of his pens, Mr. Waterman used to make a half dozen or so, go out and sell them with more or less success, after which he again returned to his bench to make another lot.

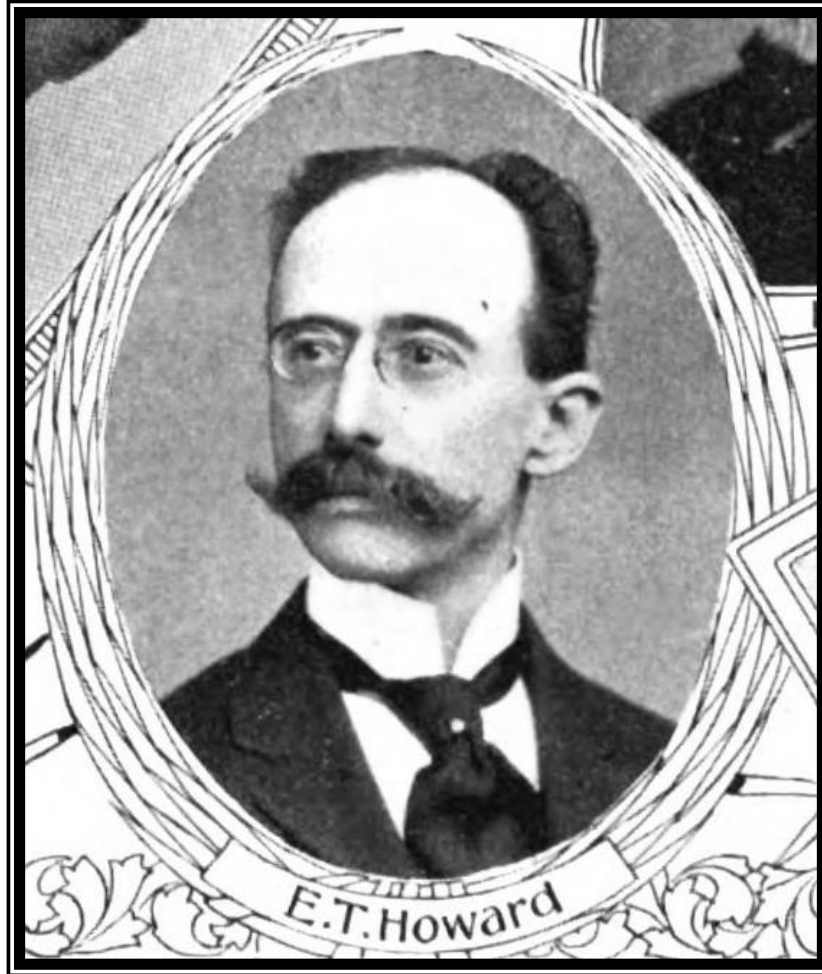

Figure 3: E. T. Howard, from [May, 1899 *New England Stationer and Printer*](#)

A later recounting by Howard in [the February, 1908 edition of *Common-Sense*](#) (which is itself a repetition of the version printed in the *Advertisers Almanack* shortly before) continues the story with more detail:

As soon as the advertisement was published replies and orders poured in from every section of the country and the supply could not be kept up to the demand. At this point it became necessary to get more capital into the business and to provide facilities for an enlarged output. From the leading wholesale stationer of New York [Asa L. Shipman's Sons] Mr. Waterman obtained a loan of \$5000 [the correct amount is \$6,500]. The business grew so fast that even the remarkable ability of the founder was tested to the utmost to keep up to the demands of the expansion. Realizing this fact and that success was assured, Mr. Waterman's backer desired a stronger control of the business.

Mr. Waterman came to me with the story of his trouble. There was ample value in the patent and in the business, but the ready money had gone into development. I advised him to form a stock company, which he did. This was the beginning of the L. E. Waterman Company, composed of Mr. Waterman and a few of us who were his friends and believed in his idea. A \$25,000 company was formed which paid the indebtedness and left a working surplus for emergencies.

From that time the Waterman business never faltered. It has grown from the little case behind the cigar stand to a business requiring several factories

Here is a firsthand account of Waterman's entry into the pen business, yet Howard provides no insight at all into how Waterman came to be situated at that cigar stand on Fulton Street; Howard's focus is on his own role in launching Waterman's company, though even there, his timeline is inaccurate. For example, Waterman apparently did sell stock in the L. E. Waterman Pen Company in order to pay off his loan from Shipman, but that occurred two years after the corporation was formed, and not until months *after* Waterman had defaulted on the loan by failing to pay the note on time. In fact, Waterman's default triggered a lawsuit by Shipman and jeopardized Waterman's ownership of his own patents, which served as mortgaged property for the note. Other chronological and factual misstatements in the Howard's account will be explored later on.

Howard's 1903 account of the Waterman Pen Company's beginnings was published after Waterman died in 1901, but luckily we also have L. E. Waterman's own recitation of those formative events just 13 years after they took place; he laid out his story in an interview published in [the July 15, 1896 issue of *Printers' Ink*](#):

A few questions brought out the fact that Mr. Waterman was a native of Cooperstown [actually Decatur], N. Y., and before inventing his fountain pen was a canvasser, insurance agent, and shorthand writer and teacher. He realized the need of a writing instrument that would combine a gold pen [nib], with a steel pen action, and a contrivance that would do away with the cumbersome ink well and he set himself a task of producing an instrument that would embody these points. The pen was invented in 1883, and at first was sold by Mr. Waterman in person, by personal canvass from office to office. The business slowly increased until another hand was required, and has since grown step by step.

....

Mr. Waterman credits his success to advertising and to the fact that he made a reliable fountain pen. [Note that Waterman here does not take credit for inventing the first "practical" fountain pen, a claim which eventually became embedded in the lore of fountain pen history.] A few questions put him in a reminiscent mood, and he told me the following story, with the aid of very little questioning on my part:

"In September, 1883, when I was just beginning to make a success with the Ideal, Mr. E. T. Howard, the advertising agent, approached me with a proposition to use the advertising pages of the *Century Magazine*. A quarter-page was decided upon as the proper space to begin with, and my first advertisement appeared in the issue for November. During the month of November I received in cash sales over the counter alone more money than the advertisement cost me, and besides received very many mail orders accompanied by cash. [Note that Waterman does not state that Howard fronted the cost of the *Century* ad.]

“While awaiting the result of the space used in the November number I had neglected to prepare the advertisement for the December issue [one wonders if really Waterman did not want to extend himself even further with no assurance of the first ad’s payback, especially if Howard actually covered that cost]. However, the result of the first advertisement being so satisfactory, a contract was made for a quarter-page in the January *Century*, and I have used the *Century Magazine* always with good results ever since. Our advertisement in the *Century Magazine* for November, 1884 [note contradiction on date], brought us in cash sales enough money to pay for the cost of the pens, the advertisement, and leave us quite a little profit besides.”

In Waterman’s own retelling, there is no insurance contract, no ink blot, no hot prospect lost; indeed, it is not even clear what Waterman’s vocation was at the time he developed his feed. The article does mention Waterman’s background as a user and instructor of shorthand, which might have fed into his interest in fountain pens, as shorthand writers (or “phonographers”) must not only have a ready ink supply with them, they must be able to keep up with the speaker; the constant re-inking of a dip pen would surely be a significant impediment to their primary task. In fact, the utility of Waterman’s fountain pen to a phonographer was to be touted in several of Waterman’s earliest advertisements, no doubt reflecting his familiarity with that profession’s encumbrances.

Despite the apparent harmony between E. T. Howard’s and L. E. Waterman’s versions of events, both their chronologies are flawed and incomplete. Waterman made his arrangement with the stationer Asa L. Shipman’s Sons to use their location by March of 1884 and Waterman’s ads and other press mentions from that month forward, such as [the March item in *American Counting-Room*](#), reflected the change, bearing Shipman’s 10 Murray Street address. We have determined that Waterman’s first ad in the *Century* did not appear until the November, 1884 (not 1883) issue, and the ad as expected gives that later Murray Street location, so unless Waterman was continuing to sell over the counter at the cigar shop on Fulton Street while simultaneously listing Shipman’s Murray Street location as his place of business, E. T. Howard could not have initially encountered Waterman at the earlier location and proceeded forthwith to sell him that *Century* ad, because it didn’t appear until eight months after Waterman had relocated. [Scattered modern claims that the publication in which Howard placed Waterman’s ad was the *Review of Reviews*, a publication that was not established until 1891, are wholly incorrect.]

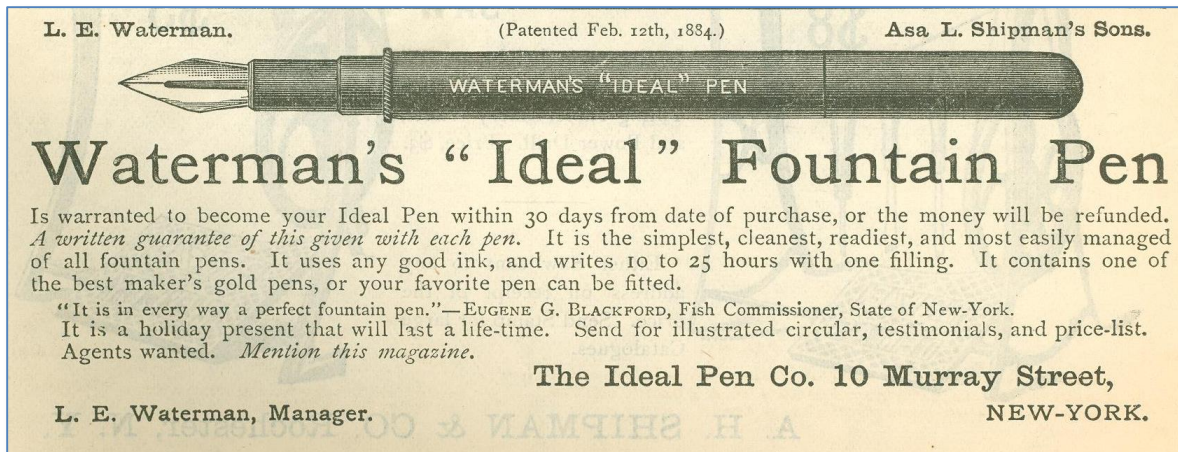

Figure 4: First Waterman ad in the *Century Illustrated Monthly Magazine*, November, 1884

Not only does Howard’s timeline not hold up, his claim that the *Century* ad was Waterman’s first ad anywhere is pure nonsense; in fact, as writing instrument historian [David Nishimura has discovered](#), Waterman had begun advertising in publications as early as late 1883, and there are several ads in trade periodicals that pre-date that first *Century* ad of November, 1884. Though perhaps not strictly advertisements, there is also an assortment of trade cards that display the company’s first address of 136 Fulton Street and that promote the pens as holiday gifts, from which we can conclude that the cards were printed prior to Christmas of 1883. Additionally, Howard’s recollection that the *Century*’s circulation had swelled leading up to the running of Waterman’s ad due to the success of their series of Civil War articles is simply wrong; in fact, the first such battle reminiscence ran in the very same November, 1884 issue of the magazine as did Waterman’s inaugural ad there.

There are several possible explanations for these discrepancies; before Waterman left 136 Fulton, Howard might have encountered him and sold him some smaller ad placements before pushing the more expensive national ad, leaving those details out of his later retelling. Perhaps Howard even knew Waterman *before* he began selling his pens at the cigar shop, but for some reason he (and Waterman) were disinclined to detail Howard’s earlier involvement—and Waterman’s activities—immediately prior to Waterman’s entry into the penmaking business. Instead, the pair may have preferred to sculpt a more romantic tale, favoring simplicity and the importance of the two men’s contributions over more mundane—or even inconvenient—facts. And it is true that Waterman and Howard forged a lifelong friendship and business association; Waterman’s loyalty to Howard was such that L. E. stipulated in his will that Howard was to continue to receive the Waterman company’s ad business after Waterman’s demise, and when Howard died in 1918, Waterman’s nephew, Frank D. Waterman, who had assumed the presidency of the company upon his uncle L. E.’s death, wrote and distributed [a glowing tribute to E. T. Howard](#) that was widely published in the trade magazines of the time.

If even these first-person accounts don’t hold up to careful examination, the question rings ever louder: What was L. E. Waterman *really* doing leading up to his setting up shop selling his patent-pending pens at the Fulton Street cigar shop? The ink-blot stories and similar recountings that appeared many years after the company’s founding have him as an insurance salesman right up to—and even somewhat

past—his invention of the feed that was the foundation of his venture. Earlier accounts, however, don't make this assertion, nor do they lay out any occupation or activity in its place. There is no explanation of through what sequence of events Waterman came to occupy the small space in the cigar shop, nor how he set himself up with the pen components he needed to assemble complete pens incorporating his novel feed.

The authors have not made an extensive study of L. E. Waterman's whereabouts during the years leading up to Waterman's appearance as a penmaker, but we have found evidence that after a half-decade absence during which he resided in New York City, [Waterman returned to the Ætna office in Boston](#) in the mid-1870s and then [was their representative briefly in Saco, Maine](#) in 1877. He did [an overlapping stint](#) as an insurance agent with Milwaukee-headquartered insurer Northwestern National [starting in 1876](#) in Boston and apparently extending at least until 1880, when he puts his name to [a petition](#) dated February 25 of that year opposing taxes on insurance and submitted to the Wisconsin state legislature.

However, we have not found any information indicating that L. E. continued his insurance activities after 1880 (with the possible exception of a puzzling listing in the 1885 edition of *Trow's New York City Directory* of an L. E. Waterman with occupation "agent" having an office at 304 Broadway). We have uncovered the fact that from [January, 1881](#) through [August, 1882](#), Waterman applied his literary talents as the corresponding editor for the railroad trade magazine *National Car Builder* published in New York, and for some period, Waterman's Kankakee, Illinois-based brother Elisha Silas Waterman—who, in the myth, supplied the wagon wheel spoke from which Lewis Edson crafted his prototype pen—"traveled throughout the west as a special representative" for the same publication, according to Elisha's biography in [History of Kankakee County](#), published in 1906. In court testimony in 1887, Waterman mentions a period of employment at the trade publication *Railroad Gazette* prior to his post at *National Car Builder*; we have found firm corroboration of this earlier job in the form of an announcement printed in Waterman's first issue with *National Car Builder*. Waterman appears to have maintained some ties with his earlier employers, as evidenced by an endorsement from a W. H. Boardman of the *Railroad Gazette* that appears in [some Waterman's ads in 1888](#). During L. E. Waterman's tenure at *National Car Builder*, the monthly magazine was headquartered first at 5 Dey Street and then at 140 Nassau Street in lower Manhattan.

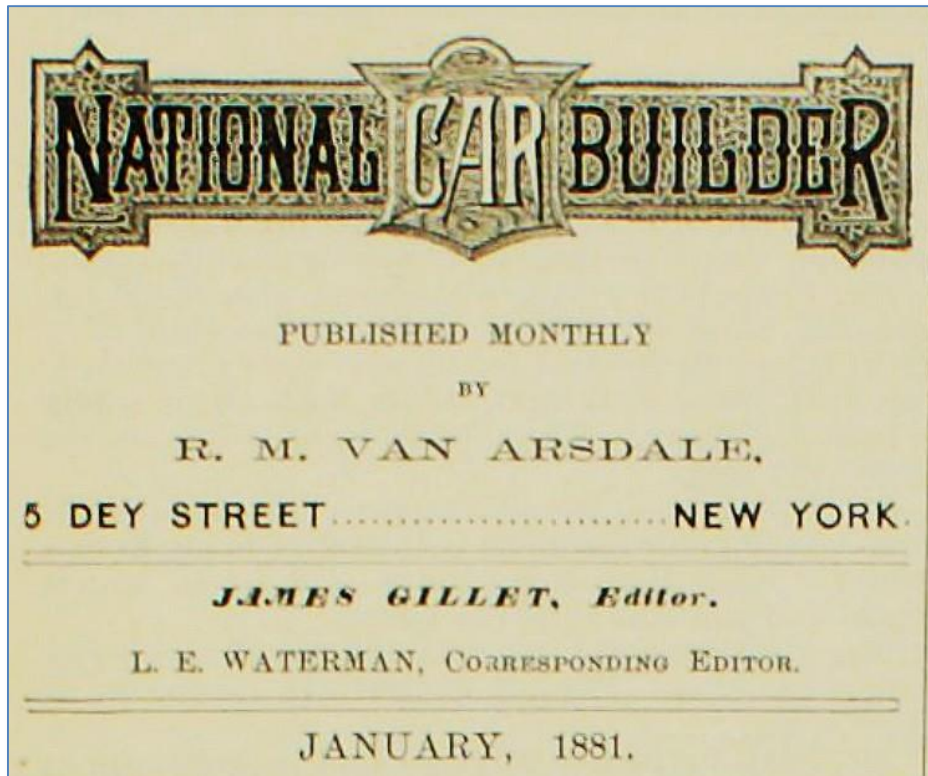

Figure 5: *National Car Builder* masthead, showing L. E. Waterman as Corresponding Editor

MR. L. E. WATERMAN, who has been with the *Railroad Gazette* several years, has connected himself with the NATIONAL CAR-BUILDER, and will act as Corresponding Editor. He is fully authorized to represent this journal in all matters of business.

Figure 6: Announcement in January, 1881 *National Car Builder*, mentioning Waterman's prior post at the *Railroad Gazette*

Both the Dey and Nassau Street locations are just a few blocks away from that cigar shop of legend on Fulton Street. But we did not discover anything further that shed any light on L. E. Waterman's activities between the end of his tenure at *National Car Builder* in August, 1882, and his appearance in 1883 on Fulton Street making and selling his pens.

Except for one item, published in a Connecticut newspaper over a hundred years ago.

An Astounding Tale

On March 5, 1910, the *Hartford Courant* ran [a human-interest story](#) entitled, "Early Days in Manchester Green; Interesting Reminiscences by Aaron Cook, Jr., of One of the Old Families."

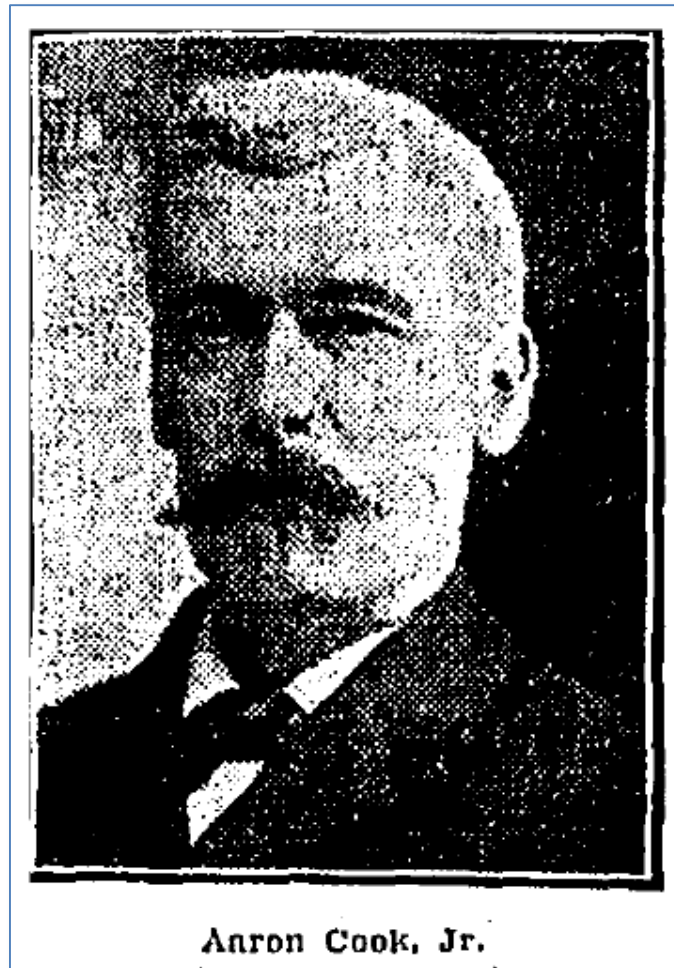

Figure 7: Aaron Cook, Jr. (From the *Hartford Daily Courant*, March 5, 1910)

Manchester Green is a bucolic small town on the outskirts of Hartford, Connecticut with a rich history of innovation and industry. In the article, Mr. Cook, who is 67 years of age and a lifelong resident of the town, tells the following story:

In 1875 a man by the name of Major Frank Holland, who had lived at Mr. Cook's father's home at times, returned after graduating from the Pennsylvania Military Academy, Chester, PA., as civil engineer. Owing to an accident which prevented his taking up surveying at once, Mr. Holland taught school at the Green for three years, as it turned out. Holland got interested in stylographic pens, which were like a pencil with a needle point, only that they wrote with ink. He took out a patent for an improved stylographic pen and Mr. Cook worked for him for about a year on these pens. One evening, Mr. Holland, Mr. Cook, and his sister Mabel were sitting in the same room at Mr. Cook's home, when Mr. Holland remarked that there would be an independent fortune for the person who could fit together a fountain of ink and a man's favorite kind of pen. Inspired by this remark, the three people together planned a fountain pen. Next day the pen was made. The tube of the old stylographic pen was taken, a nose fitted to it in which any pen, fine or blunt, could be put. It was filled from the top. For hours the

next evening the inventors took turns keeping that pen going and wrote with a fountain pen which was made in the old shop where Ben Lyman made his wagons and ploughs. The day after, the Holland Stylographic Pen Company was formed, with Charles H. Owen, Frank Holland and Aaron Cook, Jr., as members. A patent was applied for and obtained. These pens were made by this company, but were not sold as there were some defects which needed to be overcome. For instance, after writing all right for several hours, the pen would make a large splash of ink on the paper. Mr. Holland did not take advice easily, as the ingredients of his disposition, to quote Mr. Cook, were something like what is in dynamite, and exploded very easily. The spontaneous combustion of these ingredients took Mr. Holland out of town.

Though having some elements in common with Waterman's legend, the story up to this point is not especially remarkable; there were inventive people all over the country who were turning their attention to devising a better fountain pen, as a plethora of patents from the period shows. And Cook, a trained machinist who had worked for Colt Firearms, would have been more than capable of participating in the fabrication of parts for experimental pens. But what comes next in the *Courant* article is truly astonishing:

When next heard from, the Holland Stylographic Pen Company had an offer of 10 cents apiece as a royalty on what pens Mr. Holland could make and dispose of in New York. At this time he had connected himself with a man by the name of Hawkes on Fulton street, New York, to furnish the money. Holland fitted up the pens in a little corner office set off from Mr. Hawkes's tobacco store. He employed L. E. Waterman, whose fountain pen advertisements are seen now in all the magazines, to sell the pens in New York. This arrangement worked successfully for six weeks, when the same combination of dynamite exploded again, and Mr. Hawkes was left with a bunch of penholders in which his money was invested. Then Mr. Waterman stepped in and fitted up the pens and in so doing made a little improvement. By sawing two little grooves inside the case he did away with the blotting of the pen. He at once took out a patent in his own name and in one year took \$6,000 profit out of New York and how much since then Mr. Waterman probably knows. So, by a little thing, Mr. Waterman got the fortune which was foretold to come out of the fountain pen by Mr. Holland while Mr. Cook and those who thought of the scheme did not. But, at any rate, the forerunner of the Waterman Fountain Pen was first made at Manchester Green in the old Lyman shop.

Was this amazing tale just one old man's attempt to gain some undeserved publicity for important events that happened decades before, and that might be largely safe from scrutiny? Or is it possible that such a stunning story could be true, and that Lewis Edson Waterman was in fact Frank Holland's pen salesman at the shop on Fulton Street before taking over the business Holland abruptly abandoned?

Investigating Aaron Cook's Claims

We searched for evidence, starting with Cook's description of Frank Holland. Sure enough, the [records](#) of the Pennsylvania Military Academy (now Widener University) confirmed that after two years of

attendance, a Frank Holland graduated from that institution in the class of 1875 as a Civil Engineer (with a 95.8 average, no less), and he [landed a job](#) as a barometric recorder working with the U. S. government's epic Wheeler Survey, which mapped much of the western part of the United States in the 1870s under the supervision of First Lieutenant George Montague Wheeler. In fact, Holland [needed to report to the survey team early in June of 1875](#), so [he missed the mid-June commencement ceremony](#) at the PMA, though he received his diploma.



Figure 8: Pennsylvania Military Academy (from *Artwork of Delaware County Vol.9, 1897*; scan courtesy of Keith Lockhart, delawarecountyhistory.com)

Next, we checked into the wagon shop where the tinkering allegedly took place. This element of the story was highly suspect, because it seemed to be baldly appropriated from Waterman's ostensible history, as there are repeated references to Waterman having constructed his first prototype fountain pen at his brother's wagon shop (despite the fact that according to his biography in *History of Kankakee County*, Elisha Waterman had left the wagon-making trade prior to 1880 due to job-related health problems). However, the Lyman workshop referred to by Cook *did* exist in Manchester Green; we found a description of Benjamin Lyman's trade and a photograph of the wagon shop in the 1924 book, [The History of Manchester Connecticut](#) by Mathias Spiess and Percy W. Bidwell:

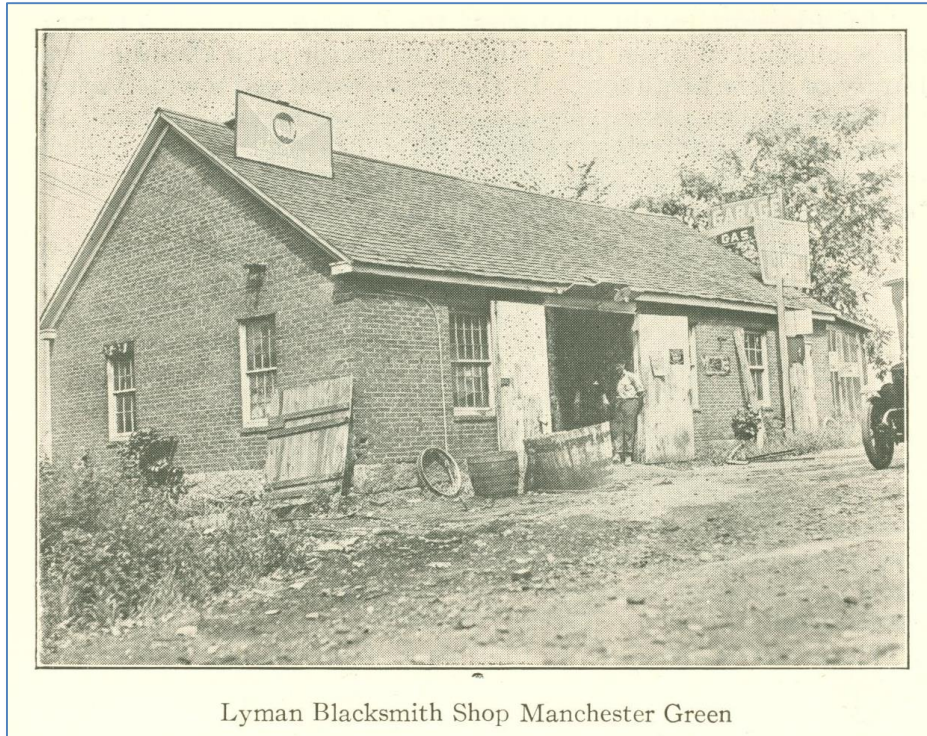

Lyman Blacksmith Shop Manchester Green

Figure 9: The wagon shop in Connecticut where Frank Holland made his prototype fountain pen (from *History of Manchester Connecticut*)

The Holland Pen Patents

After verifying the existence of the wagon workshop, we investigated Cook's claim that Holland obtained patents for his inventions. A check of the patent office corroborated Cook's story in that regard: Frank Holland was awarded three pen patents, and the timing is right, too—one is for a stylographic pen ([236,158](#), filed on September 28, 1880 and awarded on January 4, 1881), another is for a conventional fountain pen ([241,215](#), filed December 13, 1880 and issued on May 10, 1881), and the last is for a fountain pen feed alone (number [276,692](#), filed November 10, 1882 and granted May 1, 1883).

(No Model.)

F. HOLLAND.
Stylographic Pen.

No. 236,158.

Patented Jan. 4, 1881.

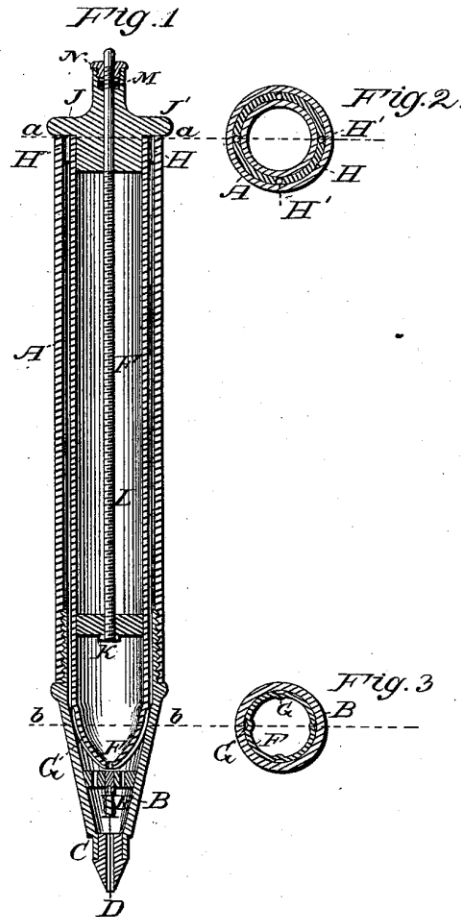

Witnesses:

Amnell B. Curtis
Wm. H. Boston

Inventor:

Frank Holland
By Geo. S. Ellis,
Attorney.

Figure 10: Frank Holland's Stylograph Patent

(No Model.)

F. HOLLAND.
Fountain Pen.

No. 241,215.

Patented May 10, 1881.

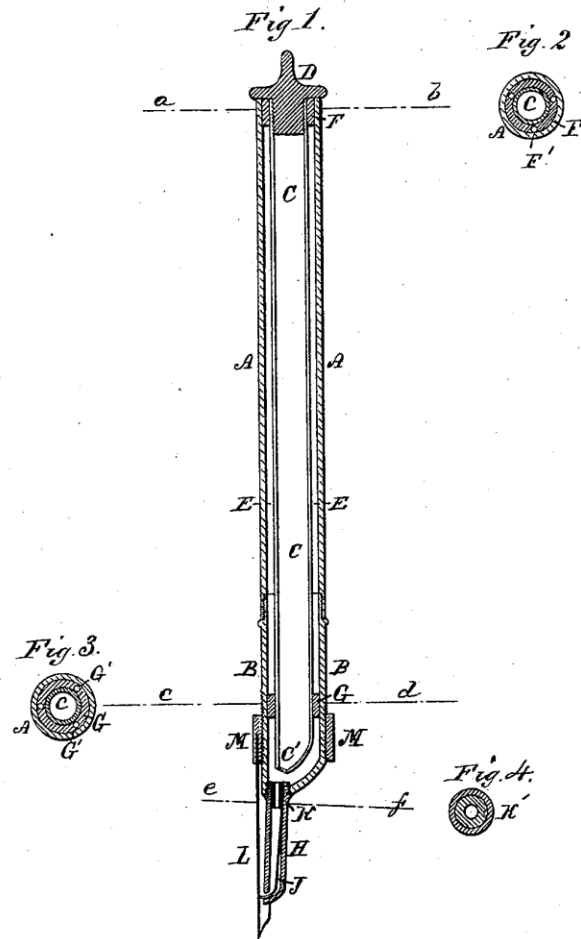

Witnesses

Mendell B. Curtis
Wilmot Horton

Inventor

Frank Holland
by Ches. C. Dill,
Attorney

Figure 11: Holland's second patent, for a fountain pen

(No Model.)

F. HOLLAND.
FOUNTAIN PEN.

No. 276,692.

Patented May 1, 1883.

Fig. 1.

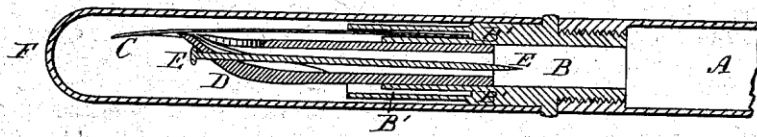
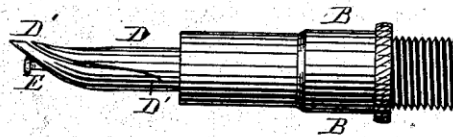

Fig. 2.



Fig. 3.



Witnesses.

*David H. Dimock,
Chas. L. Burdett*

Inventor.

*Frank Holland
by Theo. G. Ellis,
Attorney.*

Figure 12: Holland's last patent, for improved fountain pen feed

Frank Holland's Pen Company

Did “the Holland Stylographic Pen Company” actually exist? Indeed it did; the *Hartford Daily Courant* dutifully recorded the event with [a notice](#) appearing in its December 25, 1880 edition (though, to be precise, the name was recorded as “The Holland **Stylograph** Company”):

**ARTICLES OF ASSOCIATION
OF
The Holland Stylograph Company.**

BE it known that we, the subscribers, do hereby associate ourselves as a body politic and corporate pursuant to the provisions of the statute laws of the state of Connecticut regulating the formation and organization of joint stock companies, and the following are the articles of our association and agreement:—

1. The name of said corporation shall be "THE HOLLAND STYLOGRAPH COMPANY."

2. The capital stock of said corporation shall be Ten Thousand Dollars; and the said capital stock shall be divided into four hundred shares of Twenty-five dollars each share.

3. The purpose for which said corporation is formed is the following, to wit: To manufacture and sell the Holland Stylograph pen described in U. S. letters patent No. 236,154, dated January 4th, 1881, also other pens, ink or stationery, to license others if desirable, to make, sell and use the same; to buy, sell, own, hold, manage and dispose of in whole or in part said patents or other patents issued or hereafter to be issued pertaining to pens or ink or connected therewith and to buy, sell, own and deal in any property, real or personal, necessary or convenient for the prosecution of said business; and generally to do all things incidental to said business and to the proper management thereof.

4. The statute laws of the state of Connecticut relating to joint stock corporations are hereby particularly referred to and made part of these Articles, and the corporation hereby organized and established under and pursuant to said statute laws, shall have the powers and proceed according to the regulations described and specified therein.

5. Each subscriber to these Articles agrees to take the number of shares annexed to his name of the capital stock of said corporation, each share to be twenty-five dollars, as aforesaid, and to be paid for by instalments, as the directors shall call in the same.

6. The said corporation is established and located in the town of Manchester, county of Hartford and state of Connecticut. And in pursuance of said statute laws we deposit this certificate with the secretary of this state and a duplicate thereof with the town clerk of the said town of Manchester in which said corporation transacts its business, and have published the same in THE HARTFORD DAILY COURANT of the 25th day of December, A. D., 1890.

Dated at Manchester the 23d day of December, A. D., 1890.

Name.	Resid'ce.	Shrs.	Paid.
Charles H. Owen,	Manchester,	201 50 cash	\$4,000.
Frank Holland,		199 50 pd. in pat No.	
		236,154 val	\$4,000
Aaron Cook, Jr.,		1 1 cash	\$25.

STATE OF CONNECTICUT,)
County of Hartford,) ss. MANCHESTER, Dec. 23,
1890.

Personally appeared Aaron Cook, Jr., president;
Frank Holland, Charles H. Owen, a majority of the
directors of The Holland Stylograph Company, and
made oath to the truth of the foregoing certificate
by them subscribed before me.

WILLIAM B. LINCOLN,
Justice of the Peace.

1d*

Figure 13: Holland Stylographic Company Articles of Association

The details in the published notice match Cook’s description of the company’s composition, with attorney Charles Owen purchasing his shares with cash and Frank Holland buying in by contributing his

pending stylograph patent. Cook himself, whether short on funds or confidence, bought only a single share, for \$25.

Frank Holland was real, the workshop checked out, the patents existed, and the company was formed. But did Frank Holland ever actually produce any pens and offer them for sale? Once again, the answer is yes. We found evidence that the Holland fountain pen was carried at a local (and prominent) bookshop and stationer in Hartford named Brown & Gross, though for a very short time, in all likelihood. The following [notice](#) appeared once, on page 2 of the June 9, 1882 *Hartford Courant*—and never again:

The Holland Fountain Pen.
Mr. Frank Holland of Manchester has invented and put upon the market a fountain pen that really meets the demands of people who for years have been hoping for such an invention. It flows as readily as a stylograph, is as easily taken care of, and gives a real pen line, and not the unshaded pencil line of the stylograph. The new article is not itself a fountain pen. It is a holder and apparatus which are adapted to any kind of pen now in use. It is carried in the pocket, can be used any time, and carries a large reservoir of ink. The thing is a genuine convenience. It can be had at Brown & Gross's, on Asylum street, and is well worth careful examination. Those who have used it longest give it the highest indorsement.

Figure 14: June 9, 1882 notice about the Holland Fountain Pen

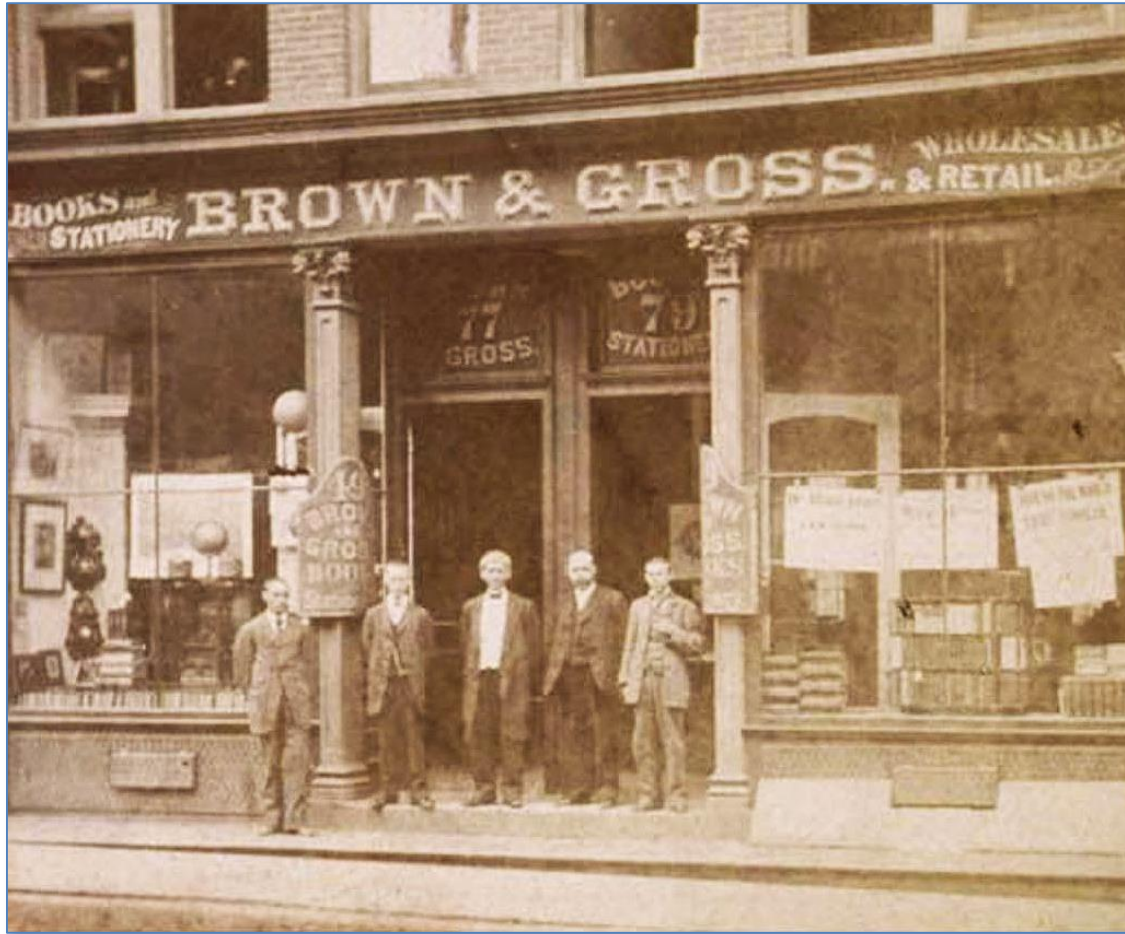

Figure 15: Stationer Brown & Gross of Asylum Street in Hartford, where the Holland Fountain Pen was sold (Connecticut Historical Society Museum)

Further sleuthing turned up several more intriguing references to Holland's invention. In the [March 15, 1883 issue](#) of the *American Bookseller*, we found the following mention:

The Holland Automatic Fountain Pen-Holder, invented by Mr. F. Holland, of New-York, is the latest and one of the best inventions yet introduced in the shape of a self-feeding fountain pen. This is made of rubber, in any pattern desired, and is capable of carrying any ordinary gold or steel pen.

Here, Holland is identified as being from—or at least in—New York, which corresponds to the path he took in Cook's story. Furthermore, on the same page, this appears:

The large stationery house of Alexander Ager shows an excellent degree of activity. Mr. Ager expresses himself highly pleased with the Holland automatic fountain pen, of which we speak in this issue.

Alexander Ager was a wholesale stationer in New York City, and the clear implication is that his firm was carrying Holland's products by mid-March of 1883. (Though we searched, we could find no further mention of Ager's involvement, and [he committed suicide in 1894.](#))

All of Cook's claims about Frank Holland's activities in Connecticut and his move to New York were checking out. Even the story of Holland's abrupt departure from Manchester appeared to be verified when we found Holland's name in [a hotel register](#) in his college town of Chester, Pennsylvania, where he checked in around June 15, 1882—just six days after that small note about his new fountain pen was printed in the *Courant*:

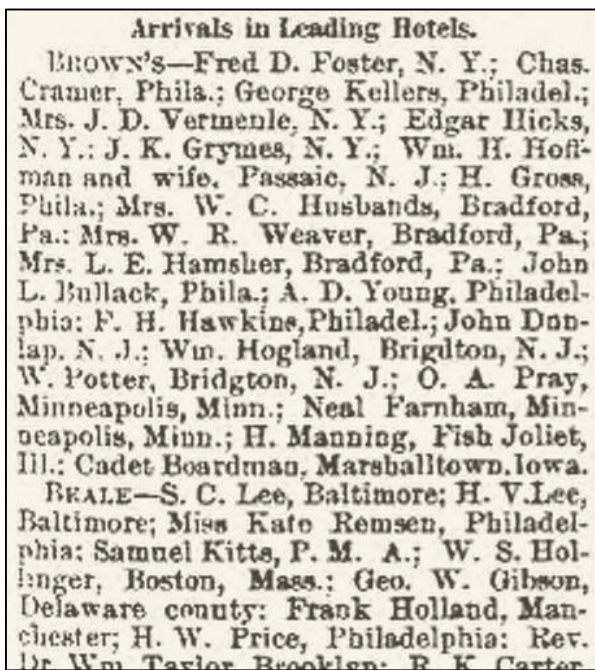

Figure 16: Frank Holland checks into the Beale House Hotel in Chester, PA, June 15, 1882

Hawkes, Owls, and Segars

What about Cook's claim regarding "a man by the name of Hawkes" who supposedly ran the tobacco store on Fulton Street and who backed Holland financially? Even if one were to assume Cook appropriated the cigar shop element from the oft-reported tale of Waterman's beginnings, how would Cook know the name of the shop's proprietor, which was never given in the accounts of the time? For that matter, was Cook even correct about the name? Extensive searches for a tobacconist named Hawkes in the area initially came up empty, but further investigation of city directories from the period turned up a "segar" shop at 136 Fulton Street in 1883 whose proprietor was named Gustav[e] **Hauck** – certainly close enough to be the "man by the name of Hawkes" recalled by Cook:

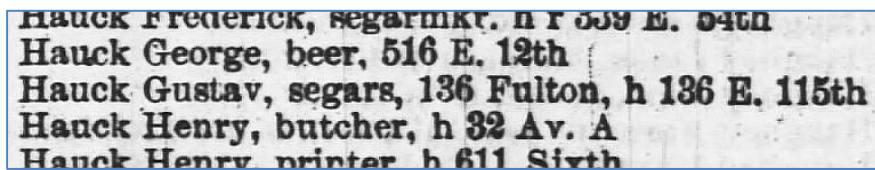

Figure 17: Listing for Gustav Hauck's "segar" shop at 136 Fulton Street in the 1884 Trow's New York City Directory

Slightly [earlier](#) and [later](#) city directories also show a cigar store at the same address, though the proprietor is give as “L. Hauck;” the use of just a first initial implies, in the custom of the time, that the shopkeeper was a woman, but the last name is Hauck nonetheless. The location continued intermittently to house a cigar shop under one or the other Hauck’s names until the fateful morning of September 15, 1891, when at 9:11am [a ferocious fire](#) swept through and “completely destroyed” the building and several others.

But the June 11, 1921 *American Stationer and Office Outfitter* article recounting Waterman’s early days actually gave the name of the smoke shop, and there’s no mention of Hawkes or Hauck—that piece locates Waterman’s fledgling business at “a kitchen table in the Owl Cigar Store.” Though “Hawkes” and “Owl” may have a raptorial connection, proposing such a substitution as an explanation for Cook’s recollection would strain credulity past the breaking point. Might there be a stronger association between Gustave (or the mysterious Ms. L.) Hauck and an Owl Cigar store?

There is. In [a directory](#) published in 1886, 136 Fulton Street housed a cigar business owned by Frederic Storm, the “Storm” of Straiton & Storm, a prominent New York cigar manufacturer whose flagship brand was the “Owl” line of cigars. The brand was so popular that Straiton & Storm cigar shops displayed large Owl signage and used owl imagery in their promotional materials. In fact, the Owl brand was so closely identified with the firm that in 1890 [the company name was formally changed](#) to “Owl Cigar Company,” and a successor company later went on to create [the well-known White Owl cigar brand](#) in 1917.



Figure 18: Trade card for a Straiton & Storm cigar shop showing owl imagery and proprietor's name

Therefore, Hauck's establishment on Fulton Street could well have been a Straiton & Storm shop featuring Owl cigars. All that would be needed to wrap up this part of the case is some direct link between Gustave Hauck, listed as the proprietor in an 1884 directory, and Frederic Storm, listed at the same address a couple of years later.

[Hauck's obituary](#), printed in the *Long Island Star Journal* on October 18, 1939, supplies that missing link. Gustave Hauck's wife was Louise **Storm** Hauck; Gustave Hauck was Frederic Storm's brother-in-law, and "L. Hauck" was Frederic's sister Louise. The Fulton Street cigar shop was all in the family.



Figure 19: Gustave Hauck, proprietor of the cigar shop at 136 Fulton Street

Thus far, Cook's story rings true. But if Lewis Edson Waterman had really sold another company's pens before making his own, wouldn't that fact have emerged somewhere along the line? In looking back over Waterman's earliest ads and profiles, there are scattered indications that this could indeed have been the case.

Glimpses of the Truth

The [1912 example of the ink-blot story](#) in *Pearson's* magazine says of Waterman's first manufacturing efforts at the smoke shop that "his raw materials were the completed pens of other manufacturers...." Was that an allusion to the Holland fountain pens Cook alleges Waterman had been selling? Sure, Waterman might have cannibalized existing pens, but had Waterman actually been *selling* someone else's products?

Within a year of Waterman's first patent application, Waterman might have let the veil slip a bit more in a large Waterman advertisement that appeared in the [July, 1884 issue](#) of a shorthand periodical called *The Student's Journal*:

“...Mr. Waterman began his connection with fountain pens by selling those at that time in the market, but soon turned his attention to making improvements in their construction...”

The ad in *The Student's Journal* is not for direct sales by Waterman, but rather has the publication itself offering the pens, and includes editorial copy in the piece in addition to incorporating Waterman's own promotional language. The magazine's introduction to their sales pitch includes the following passage:

To secure a flow [of ink] according to pen-pressure as in ordinary writing, there was invented the stylographic pen; in which the pencil-like point or style, being pressed up, allowed the ink to flow down around the point. But this, did not allow of shading of the characters—desirable in longhand, and indispensable in phonography. At last, our old-time phonographic friend L. E. Waterman, met all the requirements.

Here, it is Waterman's experience as a shorthand writer, not as an inventor, that qualifies him to develop a better fountain pen, and other early Waterman marketing materials also make mention of his pen's ability to create shaded writing. There is no mention whatsoever of any special suitability of his pen for another profession—such as life insurance agent; what made Waterman's pen interesting to students of shorthand, in addition to the obvious benefit of eliminating incessant dipping, was the pen's suitability for writing Pitman shorthand, a popular method at the time that depended on different stroke weights, which needle-pointed stylographic pens could not produce. And Waterman was amply qualified to make such an appeal; not only did he become proficient in the Pitman method of phonography before he embarked on his career in insurance sales, he was a Pitman instructor at the University of Virginia, and he also [taught a high-school class](#) in another shorthand system called Standard Phonography in Grand Rapids, Michigan in 1864. (After he started his pen company, Waterman continued to maintain his association with the world of shorthand as his venture began to grow, with continued ad placements in shorthand publications, and it is interesting to observe that a notice about Waterman's Ideal Pen Co. hiring what might have been its very first employee, James T. Toner, appeared in the [October, 1884 issue](#) of *Brown & Holland Shorthand News*.)

An earlier, even more explicit admission that Waterman's invention was an enhancement of an existing fountain pen's feed appears in the April 3, 1884 edition of *Geyer's Stationer*, where this remarkable passage appeared in a full-page article about the new Waterman "Ideal" pen:

“It is noteworthy that Waterman’s first successful pen was made by taking one of the old style pens, removing no less than six pieces, and substituting but one in their place.”

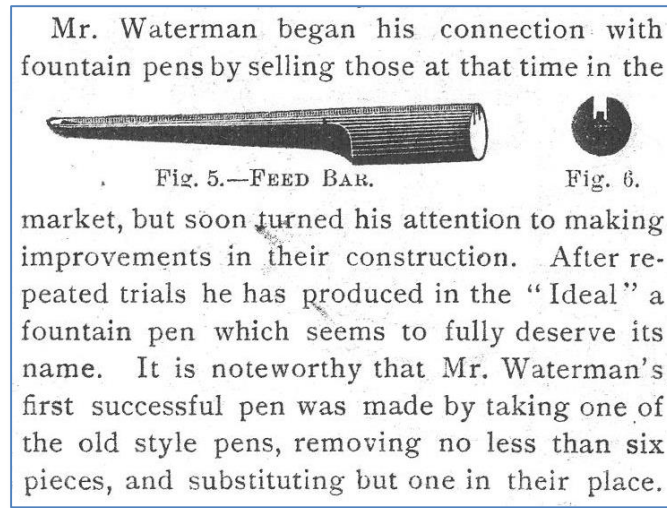

Figure 20: Detail from 4/3/1884 *Geyer's Stationer* product description

[The extensive description of Waterman’s new product that was printed in *Geyer’s Stationer* appears to be a typical placement of a marketing piece written by a company and published as a ghost-written “article” in exchange for the purchase of advertising space. Although decades later the company Waterman founded [would claim](#) the penmaker’s first advertisement in *Geyer’s* was in the May, 3, 1883 issue (which would pre-date [Waterman’s first patent filing](#) on June of 20, 1883), a careful search of physical copies at the Library of Congress revealed that Waterman’s first *Geyer’s* ad actually ran in the May 1, 1884 issue – exactly four weeks after the above-described promotional piece.]

There is more evidence that supports the proposition that L. E. Waterman sold pens before he made his own. In 1887, Waterman was called to testify as an expert witness in a patent-infringement lawsuit filed by penmaker Paul E. Wirt against D. W. Lapham and F. H. Bogart, makers of the “Rival” fountain pen. While reciting his background in the industry, Waterman declared that in addition to having used fountain pens for 25 years, he had also been a seller of others’ pens for ten years—about six years before he started offering pens of his own devising. These statements strongly corroborate the assertion that before L. E. Waterman was a penmaker, he was, at times, a fountain pen salesman, just as Aaron Cook would claim 23 years later. And finally, in the April 29, 1897 issue of *American Stationer*, [an article](#) entitled “The Story of a Fountain Pen” contains this passage:

Previous to that time [when Waterman was selling his own pens], Mr. Waterman was connected with the fountain pen business and was among the pioneers in placing fountain pens upon the market and educating as to their convenience, utility and practicalness the great American public, which is so skeptical of any innovation until it is absolutely assured of its merits. Mr. Waterman made a success of that, and when with his inventive turn of mind he gave his attention to devising a fountain pen of his own, embodying his ideas as to what experience had taught would make the ideal pen, he evolved a fountain

pen to which he gave the name “ideal,” and which is known at least through this country to-day.

Though this description of Waterman’s background came considerably later than the other references cited herein, it nonetheless adds to the body of evidence regarding his pen-related activities during the period under examination.

The Final Piece of the Puzzle Falls into Place

We know that Frank Holland had access to a wagon workshop, that he formed a pen company, and that he had obtained patents for fountain pens. We know he offered his pens for sale, first in his native Connecticut, and then in New York City. His partner, Aaron Cook, claims that Holland retained L. E. Waterman as a salesman, and we have compelling evidence that Waterman indeed sold other makers’ pens before entering the business as a manufacturer of pens of his own invention. Cook even seems to know the name of the proprietor of the cigar shop where he says Waterman worked for Holland—information that had never been published before, but that matches up perfectly when cross-checked with city directories and other descriptions of the store. But is it still possible that Cook’s claim that Holland opened a fountain pen business at the same 136 Fulton Street location where Lewis Edson Waterman famously started his company is simply made up, a colorful fable crafted by stitching together some real events from both Holland’s and Waterman’s stories in order to garner some publicity by riding Waterman’s coattails into history?

It *might* be possible it’s a fabrication—if it were not for the following two advertisements we discovered:

THE HOLLAND AUTOMATIC FOUNTAIN PEN-HOLDER.



This Holder will fit any gold or steel pen, and carry writing-ink enough to last for eighteen hours' steady writing. The Holder is made entirely of hard rubber, and is therefore non-corrosive. It has no air-tube or interior mechanism to get out of order. Has been used steadily for months by prominent business men, all of whom will use no other. A genuine iridium point gold pen (either stub or sharp) is given with each holder. Sample by mail, post-paid, \$3.50. Liberal discount to the trade.

HOLLAND & CO. 136 Fulton Street, New-York.

MR. FRANK HOLLAND, of Manchester, Conn., has invented and put upon the market a fountain pen that really meets the demands of the people, who for years have been hoping for such an invention. It flows as readily as a stylograph, is as easily taken care of, and gives a real pen line, and not the unshaded pencil line of the stylograph. The new article is not itself a fountain pen. It is a holder and apparatus which are adapted to any kind of pen now in use. It is carried in the pocket, can be used at any time, and carries a large reservoir of ink. The thing is genuine convenience, and is well worth careful examination. Those who have used it longest give it the highest indorsement.—*Hartford Courant*, June 9, 1882.

Figure 21: [Ad](#) for Holland Fountain Pen from the *American Bookseller*, April 2, 1883

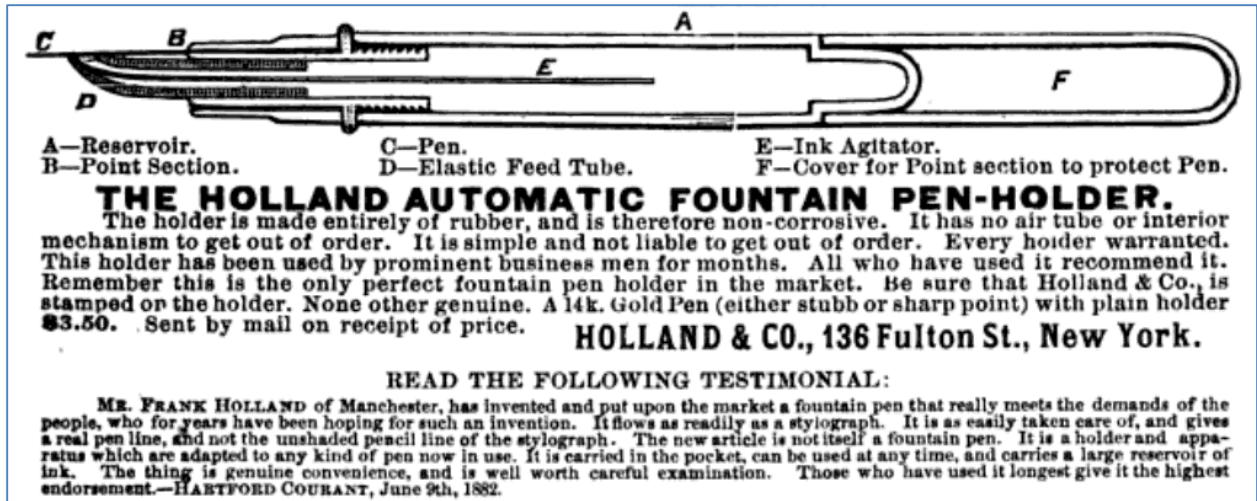

Figure 22: [Ad](#) for Holland Fountain Pen from the Medical Brief, April, 1883

The discovery of these ads provides proof that Frank Holland set up shop selling his pens at 136 Fulton Street in New York City in the spring of 1883, right before Lewis Edson Waterman, by his own account, began making and selling his own pens out of that very same cigar shop. Waterman [claimed](#) he sold his first Waterman pen on July 11, 1883 [to R. E. Bingham](#), clerk on the lighthouse tender Fern, and he [applied for his first patent](#) the month before, on June 20, so the timing is perfect; Cook says Holland only lasted six weeks before bolting from New York.

Furthermore, the pen shown in Holland's advertisements is, other than the feed and imprint, very similar in appearance to the very first Waterman-marked pens advertised and known to collectors today, though we do note that the holder style was almost certainly a standard item supplied by a true manufacturer such as Connecticut's Day Rubber, and there were other pens of the time that appear to have used similar, and perhaps identical, holders. Also, Waterman would have needed the holders re-worked to bear Waterman's stamp if they were already imprinted with Holland's name and Waterman wanted to re-purpose them. Even so, Cook's claim that Hawkes/Hauck was left with a stock of pen holders is eminently reasonable, and we speculate that Waterman may have used that abandoned inventory as the basis for his first Waterman-branded pens that bore the improved feed he had apparently designed.



Figure 23: Advertising cuts depicting Holland (top, 1883) and Early Waterman's pens (bottom, 1884)

Perhaps more eerily, the text of Waterman’s earliest ads from when he was still working from Hauck’s Owl Cigar store seems to echo the prose of Holland’s advertisements from a few months earlier:

Holland Ad	Waterman Ad
”The holder will fit any gold or steel pen”	“Takes the ordinary gold or steel pens”
“[Will] carry writing-ink enough to last for eighteen hours’ steady writing”	“holds enough to write continuously from ten to 25 hours” [Waterman pens were by this time available in several sizes]
“The holder is made entirely of hard rubber, and is therefore non-corrosive”	“The holders are made of hard rubber, which is incorrodible”
“It has no air tube or interior mechanism to get out of order.”	“There are no air-valves or other machinery, and therefore nothing to get out of order”

We suspect Waterman was simply re-using advertising copy he wrote for Holland a few months earlier.

Given all these facts, it appears that Cook’s incredible story is true. We now know that Lewis Edson Waterman was a pen salesman for Frank Holland, Waterman took over Holland’s shop, and perhaps his inventory, and started his own pen business in its place. At last, the real story of Waterman’s beginnings has been discovered.

Holland’s Participation is Pointedly Forgotten

As far as can be determined, neither Waterman nor his closest associate in those early days, ad man Edward Tasker Howard, ever mentioned the set of circumstances herein revealed when recounting the events surrounding Waterman’s launch in the pen business. They omitted the entire Holland episode when they gave their accounts, and Tasker may have gone even farther after Waterman’s death in 1901, cooking up the ink-blot fable and appropriating elements of Holland’s story—such as his use of a wagon shop to make his new pen—and replacing him with Waterman, thereby wiping out Holland’s rightful place in fountain pen history and relegating him to a memory that lived on in only a couple of men’s minds. We speculate that this was deliberate, in order to keep the focus squarely and solely on Waterman’s invention. Gustave Hauck, Frank Holland’s backer and the proprietor of the cigar shop at 136 Fulton, had no reason (or opportunity) to fill in that background, and the injured party—Frank Holland—never speaks out publicly about the matter (and he had reason to keep a low profile later in life, as will be seen).

The only other people who are known to have had firsthand knowledge of the real events resided in Manchester Green, Connecticut, and although they kept the truth alive as best they could, it was with only limited and local effect. Aaron Cook tells the story to the Hartford Courant in 1910, but it seems to cause no significant stir, and the local memory appears to have had its last public exposure in 1919, when a new park was being laid out in Manchester. On April 4 of that year, the Courant [ran an article](#) about the park that briefly recounted the story of Frank Holland’s place in Waterman’s history, and then went on to suggest that, due to Manchester’s role in the birth of the Waterman fountain pen, the park be named “Waterman Park.” Two days later, [a follow-up story](#) entitled “Dislike Name of Waterman

Park” described the backlash in Manchester against the Courant’s suggestion. According to the article, Holland’s partners Aaron Cook, Jr. and Charles Owen were still living, and residents were opposed to the “Waterman Park” designation because “the naming of a park, for anyone other than Holland, would seem to indicate that the Manchester people would approve of the acts of Mr. Waterman in stealing the patent of the fountain pen from Frank Holland.”

As far as the authors can determine, the matter was never raised again in the press. Holland’s story makes a brief appearance in William Edward Buckley’s 1974 book *A New England Pattern: A History of Manchester, Connecticut*, and there is a passing reference to Holland’s unsuccessful pen (though not the Waterman connection) in a 1991 book by Julia Keller, *Mr. Gatling’s Terrible Invention*, but the name of Frank Holland has, until now, been entirely lost to fountain pen history. In the end, Frank Holland was successfully eradicated—or perhaps it is more fitting to declare that his name was blotted out, while that of Waterman ascended to the pinnacle of fame. But as that 1919 *Courant* article said in its subtitle, “Manchester People Believe Name of Holland Should Be Honored Instead,” and we hope that our discovery initiates that process at long last.

The Missing Link?

Though some major questions have been answered, many remain—and new ones have been raised. One particularly interesting riddle is the matter of how a schoolteacher from Manchester Green, Connecticut managed to line up a New York pen salesman and a small working space in a cigar shop on Fulton Street—a city, not to mention a neighborhood, with which he has no known association. Though it is of course possible that Frank Holland advertised somewhere for a helper in New York, Waterman replied and was retained, and then Waterman made the arrangement for the makeshift shop in tobacconist Gustave Hauck’s place of business as well as getting Hauck to back the venture, this chain of events seems rather unlikely, and to date no evidence has turned up in support of it. The authors feel, instead, that there must have been a human connection at the center of the arrangement—someone who played matchmaker, as it were, having with both a connection to the Manchester area and the wherewithal to propose a hungry salesman and to scope out cheap office space, as well as a way to get started with retail sales on a shoestring. No solid evidence for this scenario has yet been unearthed, but there is a tantalizing possibility.

Though it is purely in the realm of speculation, we offer the following hypothesis: We know that Frank Holland initially retailed his new fountain pen at the nearby bookseller and stationer Brown & Gross on Asylum Street in Hartford, Connecticut, per [an ad](#) in the *Hartford Courant* on June 9, 1882. We can speculate that E. T. Howard, the ad man who purportedly discovered Waterman and induced him to begin advertising on a national scale, might well have known L. E. Waterman from Waterman’s time as an editor of *National Car Builder*. That publication’s offices were on Dey Street and then Nassau Street in New York, and we have found evidence of Waterman’s employment only through the end of his tenure at that posting, which came in August of 1882; he may have been out of work in early 1883, or seeking additional opportunities. (We also know that Waterman and E. T. Howard were both associated with the famous Plymouth Church in Brooklyn; Howard’s father, [John T. Howard, was the church’s founder](#), and Waterman’s status as a pew holder there was mentioned in [his obituaries](#), but we do not know if

Waterman had begun attending prior to his start in the pen business.) Howard, due to his vocation, was immersed in the bustle of the advertising and publishing houses with which lower Manhattan was replete, and he was surely familiar with the area and friendly with the shopkeepers (his office was at 23 Park Row in [Trow's 1884 city directory](#), less than three blocks from Hauck's cigar shop). Importantly, [Howard was also a former jeweler](#). If someone from Hartford, Connecticut saw Frank Holland's pen at Brown & Gross and was taken with it, and told Holland that he knew an advertising man with a retail jewelry background in New York who might be able to give him a start in that city, it would provide the missing link between Frank Holland and L. E. Waterman. But was there someone who in the early 1880s lived in Hartford, shopped at Brown & Gross, had a fascination for fountain pens, and knew E. T. Howard?

There was; a quotation of his begins this article. His real name was Samuel Clemens, but he is best known by the pen name of Mark Twain.

Mark Twain, Pen Collector

Samuel Clemens resided in Hartford, Connecticut in the 1880s and he had a long association with a variety of types and brands of fountain pen. He despised dip pens, [writing in December of 1887](#), "The great question of the day does not disturb me; for I believe there will be no eternal punishment, except for the man who invented steel pens," and several letters he wrote during the summer of 1880 indicate that he was, at the time, a devotee of stylographs. [He extolled their virtues](#):

"Do you notice what clean manuscript this 'stylographic' pen makes? You fill the handle of it with a single squirt of ink from a glass medicine-dropper, & it won't have to be filled again for a week. The filling is but the work of a second. It is much better than the old-fashioned fountain-pen, for that always made light marks half the time & heavy ones the other half; & you never could really regulate the ink-flow & make it uniform. You had to carry the fountain-pen in a little box; but you just shut up the stylographic as you would a silver pencil, & heave it into your trousers pocket. Admirable invention!—& costs next to nothing."

Later on, he endorsed both [Wirt](#) and then [Conklin](#) makes of fountain pens ([quipping](#), "with a single Wirt pen I have earned the family's living for many years; with two, I could have grown rich"), and he was also approached by the makers of [A. A. Waterman](#) and Sackett pens (though [Sackett's attempt](#) in 1890 to extract an endorsement from Twain was wholly unsuccessful – Twain marked the envelope "No answer" and filed it away).

Twain liked stylographic and conventional fountain pens, and he clearly was not devoted to one model or brand. But could he have encountered Frank Holland's product, which appears to have had miniscule production? We think so. Holland's pen was [retailed at Brown & Gross](#) on Asylum Street in Hartford, Connecticut, the town where Twain lived. Furthermore, Clemens did frequent business with Brown & Gross. He regularly ordered many books from them, as evidenced by invoices, checks, letters, and surviving volumes he owned or gave as gifts that bear that bookseller's ticket, and [he referred to the proprietor, William Gross, as "Billy."](#) His close relationship with the shop is described in a 1992 [article in](#)

[the *Courant*](#), which related that “Mark Twain ... spent nights in a back room in the bookstore telling ribald stories.”

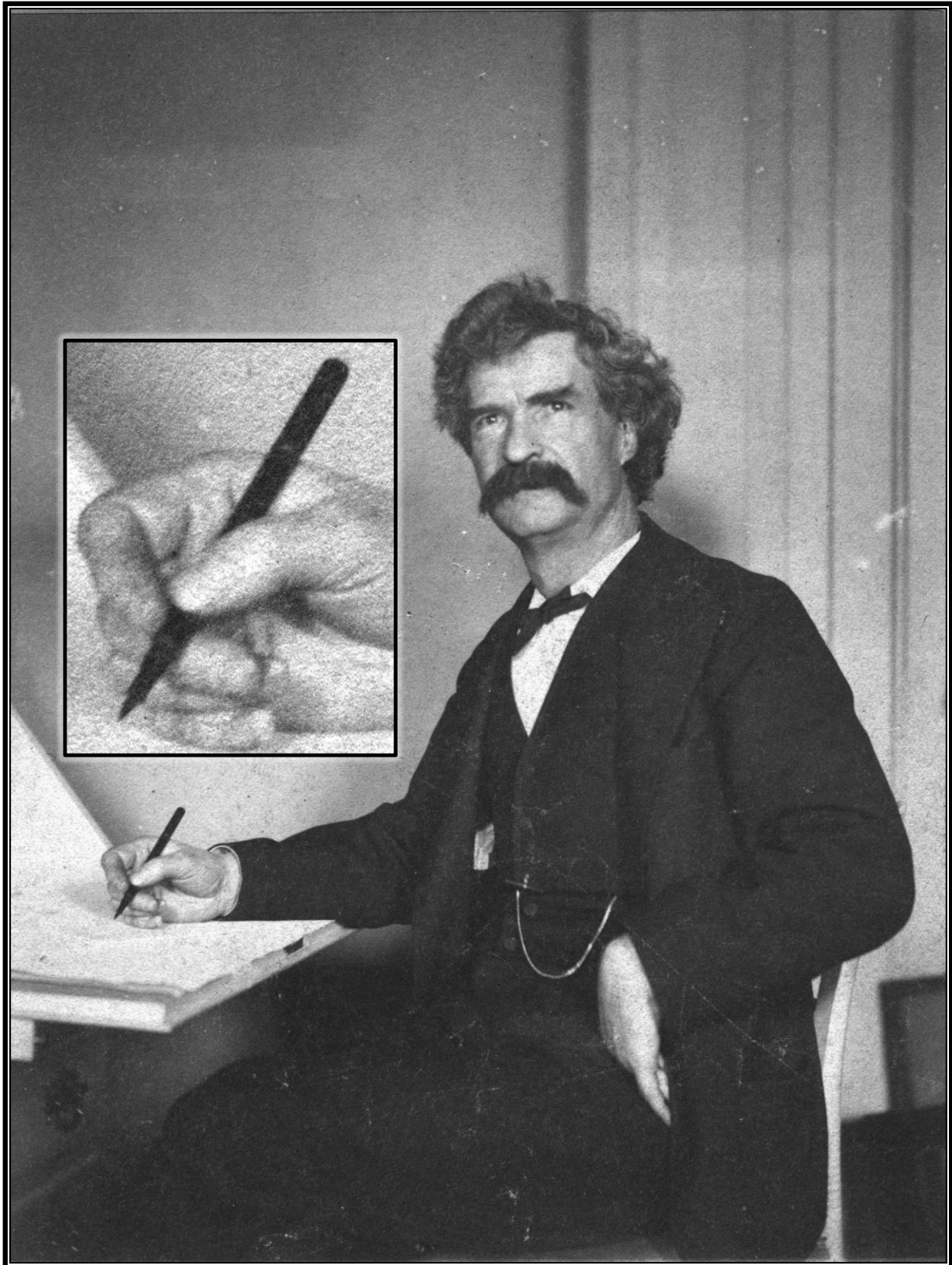

Figure 24: Mark Twain holding Wirt fountain pen with overfeed (detail, inset), circa 1886 (Mark Twain House & Museum)

Making the New York Connection

What about the other side of the link—the New York connection? In a key discovery, we found that Clemens was also a friend of E. T. Howard’s, as the two had first met in Hawaii in 1866, where they proceeded to travel the island together and then remained in contact afterwards, in part through the Brooklyn-based Plymouth Church founded by Howard’s father. The church organized a grand journey to the Holy Land in 1867; Howard was among the passengers, and Twain was a newspaper correspondent on the trip whose dispatches ultimately formed the basis of his 1869 book, *The Innocents Abroad*. (Twain, ever the cut-up, reportedly referred to Howard as “Brown” during the Hawaii excursion, [explaining](#) that it was “easier to remember.”) Howard’s granddaughter Esther Leeming “Fairy” Tuttle—103 years old and still living in New York as of this writing—[recalled](#) in her 2004 memoir *No Rocking Chair for Me* that “Gramps” regaled her and her siblings with stories of Twain’s salty-tongued visits. Clemens, apparently, was not quite as enamored of Howard’s personality, writing in [an 1870 letter](#) to a friend, “I don’t think an enormous deal of Howard, though that’s nothing against *him*, of course. Tastes differ, & 200 miles muleback in company is the next best thing to a sea-voyage to bring a man’s worst points to the surface. Ned & I *like* each other, but we don’t *love*, & we never did. I like to talk with him, & I buy little jewelry trifles there ([Howard was with the jewelry firm of Howard & Company](#) at the time, [prior to his entry into the advertising business](#)), but we don’t embrace—I would as soon think of embracing a fish, or an icicle, or any other particularly cold & unemotional thing—say a dead stranger, for instanc.”



Figure 25: Volcano House on Hilo, Hawaii, where Mark Twain met E. T. Howard (Lyman Museum)

Perhaps Clemens, who as noted was an ardent advocate of any writing instrument that claimed to improve upon the detestable dip pen, discovers in the spring of 1882 that a new fountain pen was in stock at his favorite stationer, Brown & Gross, and it was even a local product. Clemens quickly

purchases one of the new Holland pens, and, seeing its potential, he encourages Holland to pursue his fortune in New York, and offers to aid him in getting established by offering the name of E. T. Howard, his old friend who had once been in the jewelry business there. Howard, upon hearing of Holland's desire to get started in the pen business in Manhattan, thinks of his acquaintance and fellow Brooklynite L. E. Waterman, whom Howard might have known from Waterman's stint as an editor at *National Car Builder*, who had long and broad experience in selling, and who might be in need of employment. It is very likely that Howard was also friendly with tobacconist Gustave Hauck, whose [shop at 136 Fulton was so close to Howard's office at 23 Park Row](#); in support of that speculation, we offer Howard's granddaughter Esther Tuttle's statement to author Kirchheimer that her grandfather told her that each day, after emerging from the subway station on Fulton Street on his way to work, he had been buying his morning newspaper at the very shop where Waterman began selling fountain pens [personal conversation with Esther Leeming Tuttle, 2/4/2014].

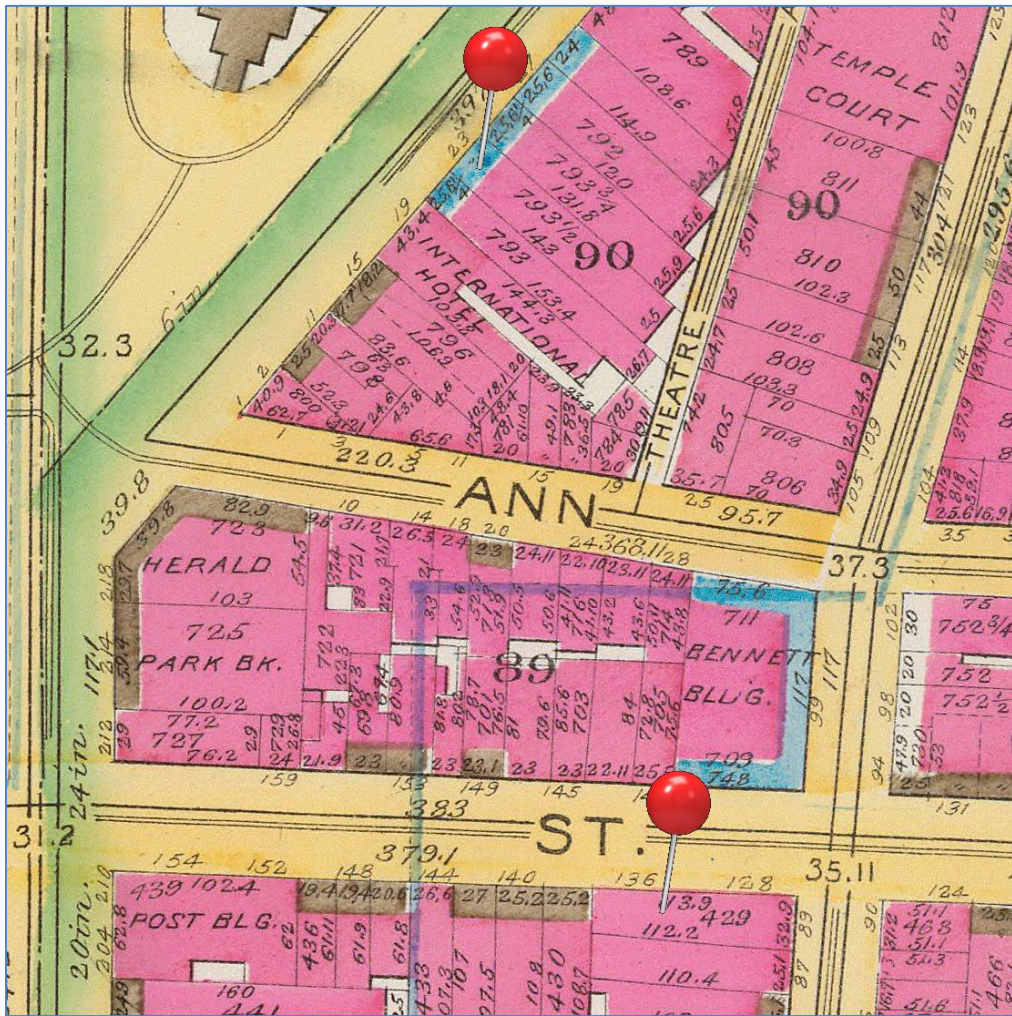

Figure 26: Detail of 1891 map of New York's 2nd Ward, showing office location of E. T. Howard at 23 Park Row (top) and Gustave Hauck's cigar shop at 136 Fulton St. (bottom) (Philadelphia: G. W. Bromley, 1891) ([Rumsey Collection](#))

After Howard makes his pitch, Waterman is agreeable, and Hauck agrees to give Holland a bit of space and to cover the cost of his pen components in exchange for giving Holland a small royalty on sales, and the deal is struck. Holland moves (or “removes,” in the language of the day) to New York in the spring of 1883, procures a stock of parts, and places his ads to run in April (Howard is the man for that, of course) with copy crafted by the facund Waterman, who then begins hawking the pens at Hauck’s. Six weeks after starting up, there is a falling out, and Holland unceremoniously vacates the premises, leaving Hauck—and Waterman—with a stock of perfectly good holders and lousy feeds. Waterman sets about modifying the feed and comes up with a version he thinks enough of that he applies for a patent on it in June, then improves his feed and files again in September and begins fitting Holland’s leftover holders with his modification. While Waterman continues to sell pens over the counter at Hauck’s cigar shop, he places a few new ads under his own name and gets a flow of orders steady enough that in early 1884 he strikes a deal with Asa L. Shipman’s Sons to make use of their 10 Murray Street location for his budding enterprise. E. T. Howard checks in on him in the fall of 1884 and, seeing that Waterman’s improved pen is starting to catch on, trusts him for the relatively substantial cost of a placement in the *Century Illustrated* for November, 1884.

Again, the Twain connection is purely conjecture; there is no direct evidence of the acts about which we have hypothesized. After all, did Twain even know about Frank Holland’s pen?

Getting Twain on the Same Page

There is one more crucial clue that pertains to the speculation about Mark Twain being the missing link between Frank Holland and E. T. Howard. The entire hypothesis depends on Twain’s knowing about the existence of Holland’s new fountain pen. Can it be definitively established that Twain was aware of it? If he were to have learned of the instrument, the most likely scenario is that he would have come across the one and only notice about the new pen that was posted in his local newspaper, the *Hartford Daily Courant*, on June 9, 1882. But how could we possibly ascertain, 130 years after the fact, that Twain even read the paper that day, much less that he took note of the Holland Fountain Pen’s mention and decided to acquire one?

In pursuit of evidence that might support our speculation, we obtained Mark Twain’s personal journals for the period from January, 1882 through February, 1883, and searched them. And we found what we were looking for: at some point, Twain wrote himself a reminder that includes a shopping list of items that he wanted to purchase from the stationer’s. The last item listed, just after “fancy paper,” is a “Holland Fountain Pen.”

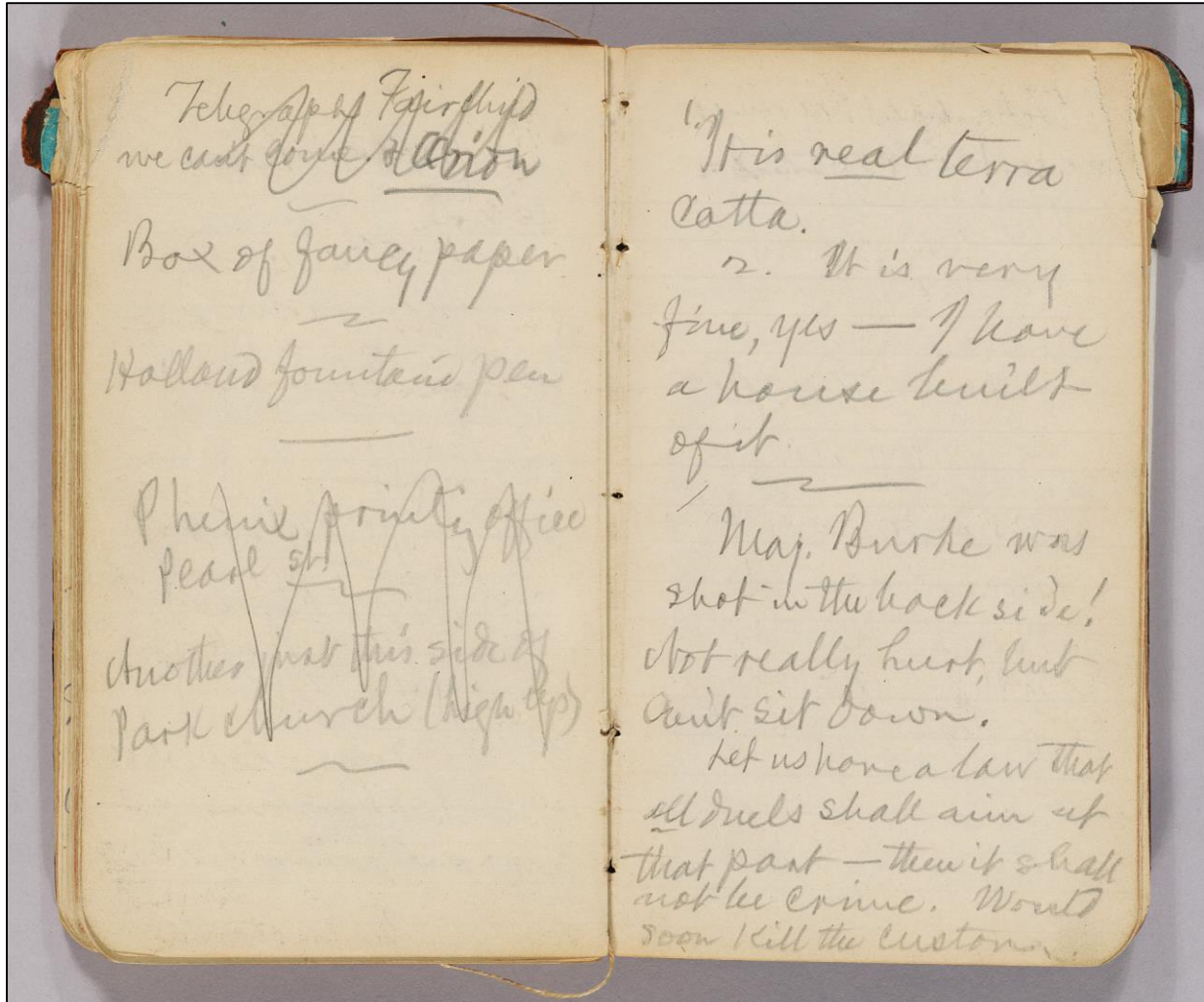

Figure 27: Mark Twain's Journal showing notation, "Holland fountain pen" (The Mark Twain Project, The Bancroft Library)

But the entries in these notebooks are largely undated. How can we know when the note was written, and thus whether it could refer to a period when Holland's pen was available at Brown & Gross, and furthermore, how can we rule out the possibility that it instead refers to the later *John* Holland brand of fountain pen? The evidence is right on the page. Two lines above the note about the Holland pen is a reminder for Twain to telegraph his brother, Orion, regarding their mother's poor health; the entry is struck through, indicating Twain had completed the task. Orion replied in a note dated June 9 [1882], saying, "...your dispatch came this afternoon," clearly indicating that Twain's telegraphed message was also sent on June 9, 1882—the same day the notice about the Holland Fountain Pen appeared in the *Courant*.

Can we deduce whether Twain actually read the *Courant* on June 9? On the journal's previous page, Twain jotted, "Maj. E A Burke of Times-Dem duel with C H Parker, of the Picayune—at the Slaughter House June 7—at 5th shot Burke shot through both thighs." This is a reference to a duel between two newspapermen in New Orleans, which took place on June 7, 1882. There was [an article](#) about the outcome of the challenge in the *Courant* on June 8, the day before the Holland advertisement appeared;

it is logical that this was the basis for Twain's note, which shows that Twain read the *Courant* on the 8th, but it falls short of proving that he also read the paper the following day, when Holland's Pen was described.

However, a careful reading of the June 8 duel article reveals that it does not contain either of the two specific details Twain mentions—that the 5th shot did the damage to Burke, and that he was shot in the thighs. But an examination of the following day's paper uncovered a much longer, more detailed [article](#) about the match entitled "An Affair of 'Honah'," and it includes both of those facts, and thus must have been the article upon which Twain based his comment. That article ran on June 9, 1882—the same day as the Holland notice. But that's not all: the article appeared on page 2—the very same page in the *Courant* on which was printed the notice regarding the new Holland Fountain Pen.

Given this evidence, we believe Mark Twain knew about Frank Holland's new fountain pen, and that he took an interest in examining it, which might have provided the impetus for the above-theorized chain of events that ultimately led to the birth of L. E. Waterman's pen company.

Who Was Frank Holland?

From the fragmentary information we have been able to gather, it appears that Holland's life was punctuated by sudden changes of scenery triggered by his volatility. This pattern led us to wonder about Aaron Cook, Jr.'s remark that due to an "accident," Holland was unable to pursue the profession of civil engineer for which he had studied at the Pennsylvania Military Academy. In fact, Holland *had* worked as a civil engineer for the Wheeler Survey. However, when we examined the details of his service, something didn't add up. The survey's fiscal year started on July 1st and ran through the end of June, and Holland joined the team near the end of the 1875 fiscal year at the start of June, 1875; [he is listed in the survey's 1875 annual report](#) as serving through the end of that fiscal year, which would have been June 30th, 1875. He then performed some field work for the survey's 1876 fiscal year, as evidenced by [the mention of his ascent of Mt. Whitney](#) (Fisherman's Peak) on September 24, 1875 in the massive final report submitted by Lieutenant Wheeler in 1889, and Holland is listed as a survey party member in a note stashed in a tiny time capsule recording an excursion on October 9, 1875 and [discovered accidentally fifty years later](#) at the summit of Deer Mountain in California's High Sierra. But there is a discrepancy: [Holland is not listed](#) in the 1876 annual report as being a member of the survey, and in fact, there is no mention whatsoever of him in that document, although the operation kept meticulous records as was fitting for an effort headed up and staffed largely by members of the military. Furthermore, if Holland had sustained some sort of injury that forced him to separate from the survey during the 1876 fiscal year, that likely would have been documented in the year-end annual report, as is evidenced by similar entries for other team members. And Holland was definitely gone from the survey team long before the end of the 1876 fiscal year, as he shows up as a grammar instructor back at the Pennsylvania Military Academy for the spring, 1876 session, as indicated by an entry in the class schedule of cadet C. C. McLain, discovered on page 15 of [McClain's PMA scrapbook](#) (McLain also recorded on page 18 that Holland was a smoker who favored "Fruits & Flowers" brand tobacco from E. T. Pilkinton of Richmond, Virginia). Given Holland's other instances of abrupt departures under unpleasant circumstances, we wonder if he had some sort of run-in during his fleeting tenure with the Wheeler Survey that precipitated a quiet dismissal and a scrubbing of his participation from the reports.

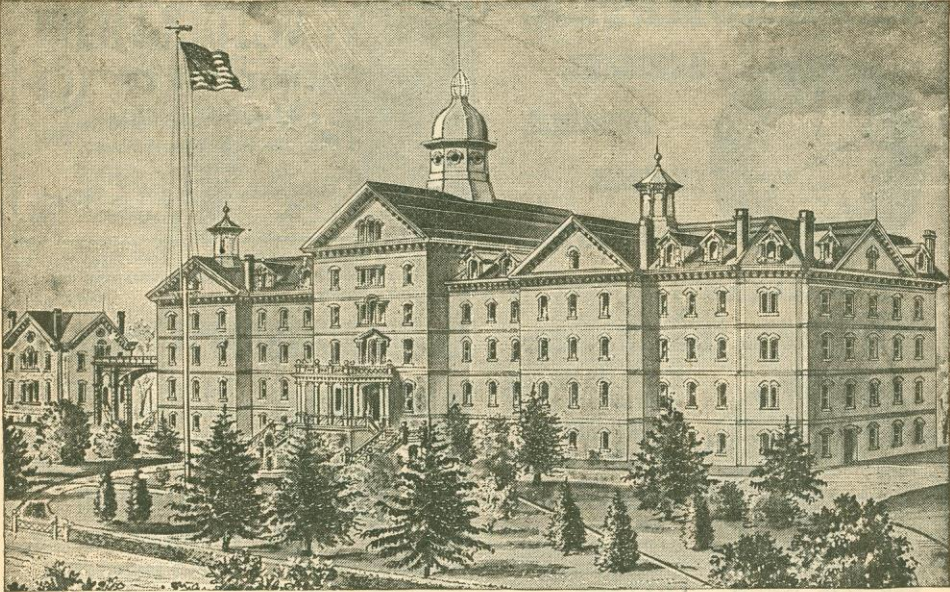

PENNSYLVANIA MILITARY ACADEMY, CHESTER.
24th Year Opens September 16th.
NEW AND COSTLY BUILDINGS, SUPERIOR EQUIPMENT, THOROUGH INSTRUCTION.
A MILITARY COLLEGE.
Civil Engineering, Chemistry, Classics, Preparatory Department. **Military Department**, second only to that of the National Academy at West Point. **COL. THEO. HYATT, Prest.** (*Mention this Magazine.*)

Figure 29: Advertisement for Pennsylvania Military Academy, where Frank Holland attended and later taught (Harper's Magazine Advertiser, 1885)

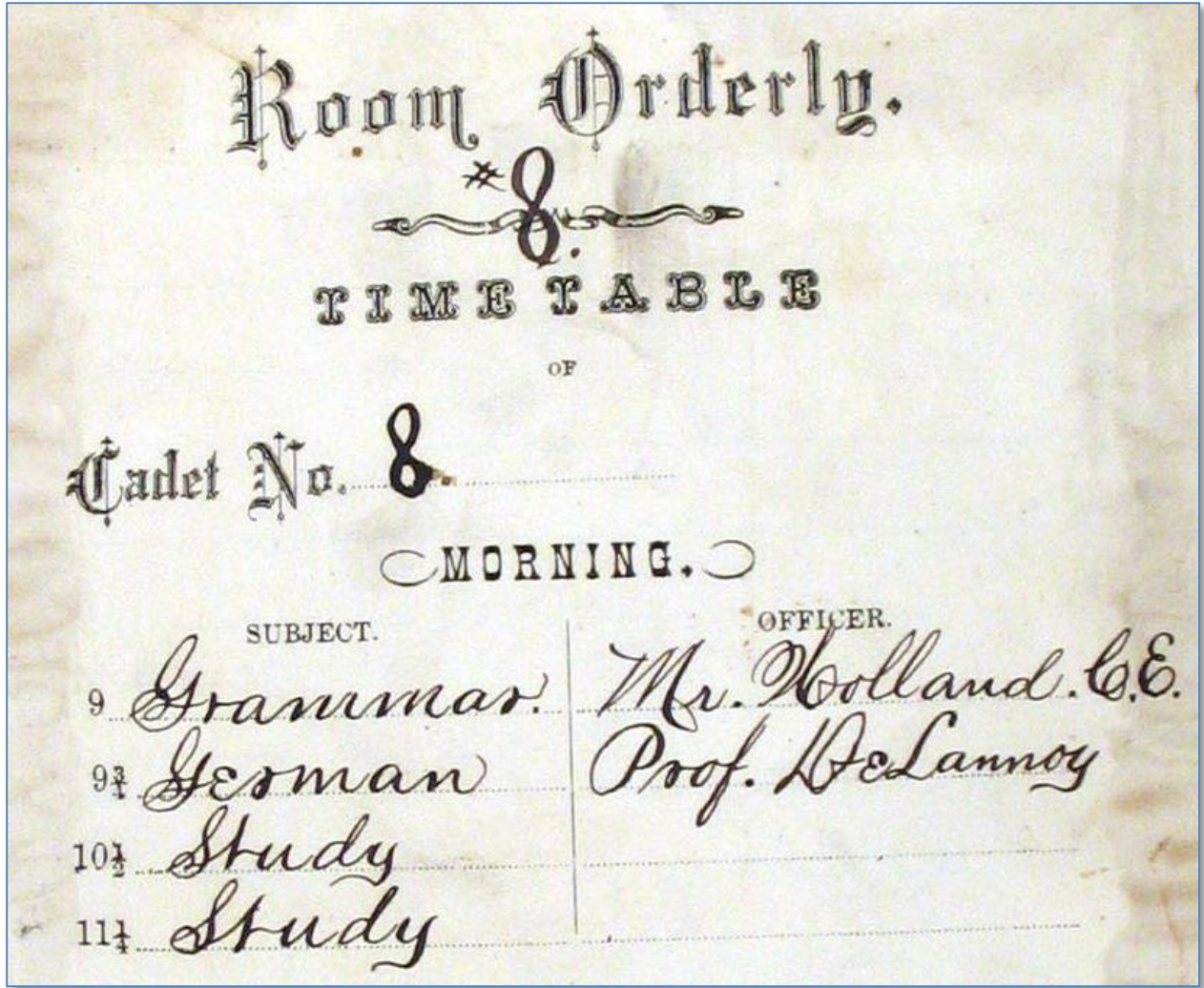

Figure 30: Detail from cadet C. C. McLain's spring, 1876 class schedule, showing Frank Holland as grammar instructor

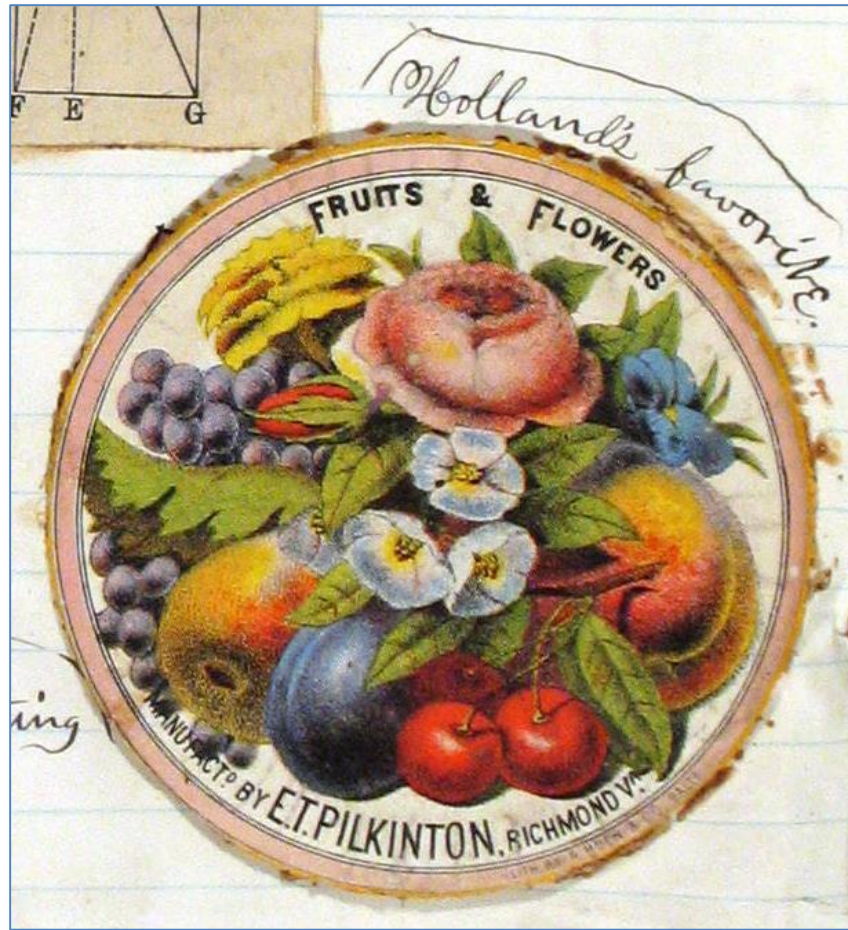

Figure 31: Detail from C. C. McLain's PMA scrapbook showing Frank Holland's preferred brand of tobacco

Holland didn't last long at his teaching post at his alma mater, either. By 1877, he is back home in Manchester Green, teaching school—though he is listed in the [April 28, 1877 issue of *The Reveille*](#), the PMA cadet newsletter, as being not merely a member of the teacher corps, but rather as the principal of the school. This looks like a bit of résumé -plumping by Holland, as Dwight Bidwell is named as holding that post from 1871 through 1882 in the 1923 [History of Manchester Connecticut](#) (itself co-authored by another Bidwell—Percy, in this case, along with Mathias Spiess). Holland may also have put some of his military training to use back in Manchester, as he is listed as being a Constable there in the [1879 Connecticut Register](#), along with yet another member of the large Bidwell clan in the person of George Bidwell.

MANCHESTER. Clerk, Reg., and Treas., Daniel Wadsworth. Selectmen, Clinton W. Cowles, Henry A. Griswold, William H. Cheney. Const., George A. Bidwell, Frank Holland, Diodate B. Russell, Frederick W. Wells, Call, George W. Bidwell, C.

Figure 32: Frank Holland listed as Constable in Manchester, Connecticut in 1879

Holland Goes AWOL

And what became of Frank Holland after he abandoned his pen business in New York? The 1974 *New England Pattern*, in its brief mention of the Holland-Waterman story, [says](#), “he seems to have failed to solve the blotting problem, and finally left for the Klondike,” but this is nonsensical, as the [serious pursuit of gold in that territory](#) was not to happen until over a decade later, and there is no evidence that the book’s source for the Holland tale was anything other than the Cook memoir in the *Courant*, which makes no such claim. We did discover that Holland briefly [joined the faculty](#) of the Cayuga Lake Military Academy in New York in 1890 as an instructor in mathematics and military tactics, and then [bought into, and became the principal of, the Poughkeepsie \(NY\) Military Institute](#) in August of the following year. But then, one more time, Holland’s incendiary personality got the better of him, and he exploded spectacularly one late winter weekend.

By all accounts, Holland had done a fine job running the Poughkeepsie school, though there were reports filtering out of problems with student discipline, raising questions as to the firmness of Holland’s grip at the helm. But that paled in comparison to the stunning events that unfolded during the weekend of February 19, 1892. On that Friday, Holland received a letter from a young lady with whom Holland had become smitten, and the contents of said missive caused him to abruptly leave the school grounds. He did not return until Sunday, when he was in a drunken stupor, and he shuttered himself in his office for two days. On the Tuesday following, he finally emerged, left the campus with \$1,000 in students’ tuition money, withdrew from the bank an additional \$500 from the school’s account, and then disappeared. [One newspaper article](#) noted somberly that “those who have known him better in the past say that there has been a suspicion of something not exactly right in his manner, that he did not always act as he wished others to act,” which corresponds neatly to his prior episodes that followed a similar pattern (less the embezzlement). That spring, the Poughkeepsie Savings Bank [sued](#) Holland and the other owners of the military school; the bank won, and a decree was entered by the state Supreme Court on July 23, 1892 ordering [the foreclosure sale of the institute](#).

According to alumni records at the Pennsylvania Military Academy, Holland then [moved to Brooklyn](#), and though he is still listed by his *alma mater* as residing there [as late as 1929](#), the school had [sent out a call](#) in 1927 for help identifying Holland’s whereabouts and business activities, but there is no indication that request was ever answered, and it may well be that PMA was just repeating, year after year, the old information they had on Holland’s whereabouts. No Frank Holland of the right age and place of birth appears in the federal census surveys from 1880, 1900, 1910, or 1920 (nearly the entire 1890 census was destroyed by fire in 1921), nor in any state census we have examined. We haven’t turned up anything to indicate that Holland ever wed or had children, or that he had any relatives at all. The Society for Savings in Hartford, a local bank, [reported in 1911](#) that Holland had an unclaimed deposit there in the amount of \$23.78, and the account was still untouched [the following year](#), when it had modestly grown to \$24.72. To date, no obituary for Frank Holland has been found, and [a headstone for a Frank H. Holland at Fairview Cemetery](#) in South Coatesville, Pennsylvania, though initially promising, has proven not to be his. The marker lists a year of birth of 1852, but the 1870 national census lists two Frank Hollands—[one 18-year-old](#) from that same county of Chester, PA, and [another, one year older at](#)

[19](#), whose residence is Manchester, Connecticut; clearly, the latter is the subject of this story, and the former is the man to whom that gravestone belongs.

The Surprising Childhood of Frank Holland

Frank Holland seems to have been a troubled man with a dark side, as his repeated explosive episodes demonstrate. We found another description of Holland's behavior that provides further insight into his nature. In 1910, two days after the *Courant* ran its story profiling Aaron Cook, Jr. in which Cook tells his tale about Holland's fountain pen venture, the paper ran [a small item](#) about the head of the local volunteer fire department entitled, "Chief Sheridan Remembered Him:"

Chief John F. Sheridan read with much interest the story in Saturday's "Courant" on the early days of Manchester Green and especially that part relating to Frank Holland, the inventor of the fountain pen. Frank Holland was teaching at Manchester Green when Chief Sheridan attended school there and he recalled distinctly the way that Holland had of punishing boys who were bad. Instead of using a birch switch, as was the fashion in those days, he would take the culprit and toss him into the air so that he would just hit the ceiling, catch him as he came down, give him a shake, and throw him up in the air again. He would continue this practice until both the boys and himself had had sufficient and then would stop. The chief would not say whether he ever made a bouncing ball for the inventor school teacher.

In an effort to find out how Holland's formative years might have shaped him into this sort of person, we looked earlier and earlier in his life, trying to find some scrap of information that would yield a clue about him. The aforementioned [1870 census](#), which lists Holland as being 19 years old, shows him living in Manchester with a couple in their early 50s, but they are not his parents, as they are named James and Mrs. Fox. We wondered if Holland might have separated from—or *been* separated from—his family at an early age, but what we found next proved just how accurate that speculation had been.

Then, as now, the national census took place every ten years, and thus the previous census was in 1860, when Holland would have been nine or ten years old (depending on the date the census was done). Sure enough, in the [1860 census book](#) for Hartford, Connecticut, a ten-year-old boy named Frank Holland is listed. Oddly, though, rather than being a resident of a household, with parents and perhaps a few other family members listed with him, Holland's name appears in a long list of children of similar age—dozens and dozens of them, all at the same location. And on the left side of the page, written vertically, is a notation that explains the housing of so many youngsters in one place:

Inmates of the Hartford Orphan Asylum	John Hugh	11
	Joseph Fenwick	11
	James Pickett	11
	Charles Piquet-	11
	Thomas Piquet	11
	Frederick Piquet	11
	John Dolan	11
	Dwight James	12
	Frank Bristol	10
	John Piquet	10
	Frank Holland	10
	Walter Loring	10
	Daniel Holland	9
	Charles Bristol	8
	Alexander Curtis	8
John Willison	8	
James Dunham	8	
James LaChance	8	

Figure 33: Detail of 1860 census, showing 10-year-old Frank Holland

The annotation reads,

Inmates of the Hartford Orphan Asylum

Frank Holland, it turns out, was raised in an orphanage in Hartford. We do not know the circumstances under which he entered the facility, which by all accounts was a benevolent institution that tried to teach the residents—or “inmates”—a trade so that they could support themselves respectably when they reached their majority. However, we cannot help but wonder about how such an experience—and what led up to it—might affect a child growing into a young man, and how the twists and turns of Holland’s life are products of this unfortunate upbringing.



Figure 34: Hartford Orphan Asylum (*Architectural Record*, v. 7, n. 4)

Shards of a Mysterious Life

Despite extensive efforts, we have not been able to locate even a single photograph of Frank Holland, and the only words we have in his own voice are in [a sharp-tongued letter](#) to the *Hartford Daily Courant* written November 11, 1881 about a local election involving his business partner Charles Owen, and in [another acerbic note](#), this one to *The New York Times*, complaining about the circuitous route a letter addressed to him had taken. Holland left us only the scantest scraps about his life. Even Holland's handwriting has proven all but impossible to find; a careful examination of his patents shows that his attorney signed Holland's name for him. Only a single authentic signature is known: the terse inscription in a pupil's autograph album from Holland's time as a schoolteacher in Manchester Green, Connecticut. "Your friend, Frank Holland," it reads, in a simple, unshaded hand apparently wielding a stylograph, perhaps of his own invention.

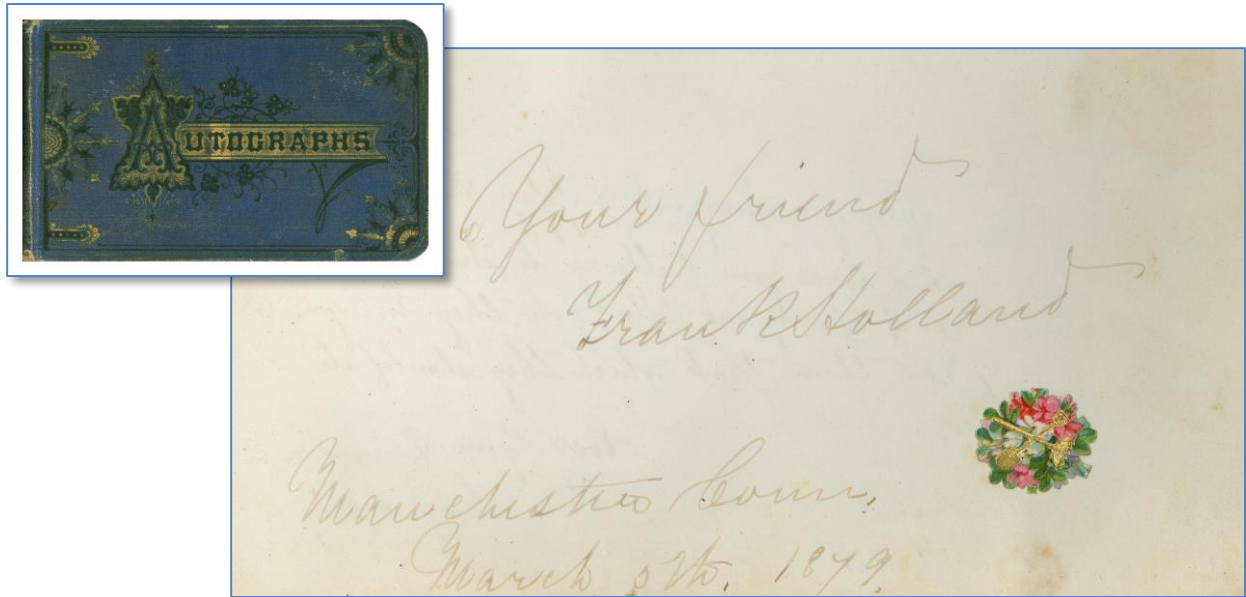

Figure 35: Frank Holland's signature, from Maggie Sheridan's autograph album (inset)

We hope that at least one of Holland's ambitious but flawed writing instruments survived as mute testimony to his existence; if any readers come across an example, the authors would appreciate learning of it. It is perhaps fitting that the man who could be considered the first fountain pen collector—Mark Twain—might have been one of the very few owners of a Holland pen, though if he was, the item has apparently been lost long ago, perhaps flung aside after blotting on a freshly-written page.

Conclusion

The lives of Frank Holland and Lewis Edson Waterman took very different paths before they converged, fleetingly, at a cigar shop at 136 Fulton Street in New York City. Just a few weeks later, an explosion drove their lives apart again, and thus unlinked, they found their futures; Holland's lay in infamy, and then obscurity, and Waterman's in fame, and ultimately, immortality. Frank Holland's dream of a great fortune being bestowed on the man who made a good fountain pen was finally realized, but tragically he was not the beneficiary of his own prophesy. During their brief time together, that dream passed from the volatile Holland to the steady Waterman, who brought it to fruition. But despite his failure to realize his vision for himself, Frank Holland deserves nonetheless to be remembered for his crucial role in fountain pen history.

Postscript

Even if all of Frank Holland's fountain pens are lost forever, he did leave us with something lasting, though ironic, as a result of one of his labors. One day in the autumn of 1883, a young man and his father were hiking the majestic Sierra Madre mountain range outside of Los Angeles. The older man, John H. Painter, was a Quaker from Iowa who in the late 1850s had [befriended and sheltered the abolitionist John Brown](#), and his home had been used as a station on the Underground Railroad, aiding

fugitive slaves and abolitionists sought by the law. Brown confided in Painter his plan to attack the United States armory at Harpers Ferry, Virginia in October of 1859, and despite the conflict with his pacifistic Quaker faith, Painter had supported Brown's plan, and had even shipped Brown's raiding party over a hundred guns under false cover. After the Civil War, Painter moved west with his family, and he was a founder of the city of Pasadena, which lay below the ridge he and his son Alonzo were exploring on that November day.

During their climb, the pair [stumbled across a fascinating artifact](#): a portion of a surveyor's notebook dating to 1875, nearly a decade earlier. The papers recorded the names and heights of various peaks in the range, but there was also a remarkable notation about one summit in particular. The document explained that the party of three surveyors had tried to scale one of the as-yet unnamed mountains in the area to record some observations in furtherance of their mission, but they had been thwarted in their repeated attempts due to the inaccessibility of the feature. In retaliation, perhaps, the group, representing the Wheeler Survey and consisting of Frank Holland and two others, had hung the label of Disappointment Peak on the object of their frustration. One final note: Though it played no role in the party's activities that day, lying to the northeast, and towering almost a half-mile higher than the summit Holland could not attain, was Waterman Mountain.

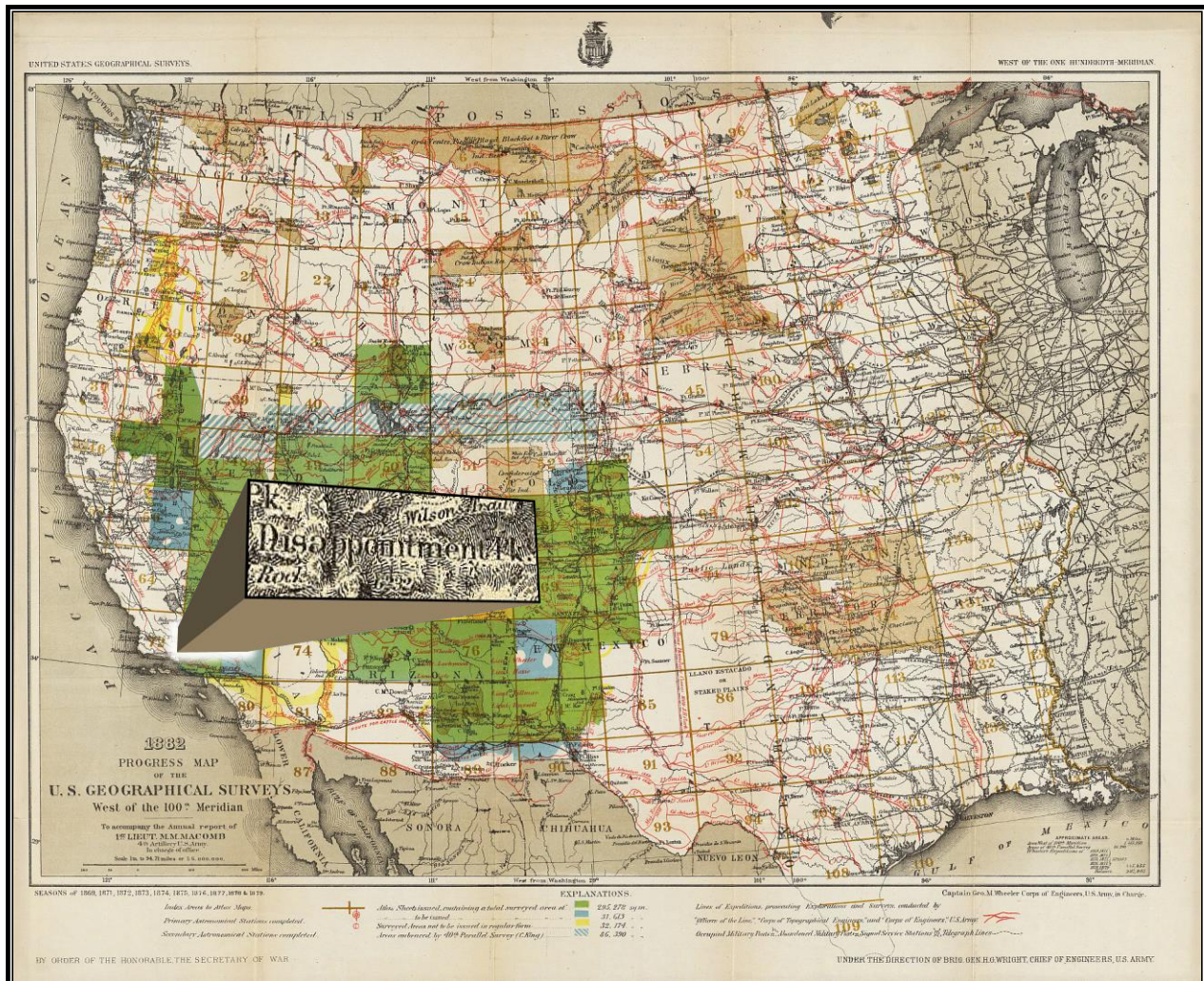

Figure 36: 1882 Wheeler Survey map, showing Disappointment Peak detail from land use atlas sheet 73 (inset) (Rumsey Collection)

The Authors wish to extend their thanks to the following people and institutions:

- Esther Leeming Tuttle
- [The Manchester Historical Society](#)
- [The Connecticut Historical Society](#)
- [The Lyman House Memorial Museum](#)
- [The Mark Twain Project](#)
- [The Mark Twain House and Museum](#)
- [The New York Historical Society](#)
- [The Widener University Archives](#)

The authors can be reached at rimakis@gmail.com (George Rimakis) and kirchh@comcast.net (Daniel Kirchheimer).

Copyright 2014 George Rimakis and Daniel Kirchheimer. All Rights Reserved.